

NOTE:
1. 08743A R303_004_004 Rev1.1-1.102
2. 08743B R303_004_004 Rev1.1-1.103 doc out

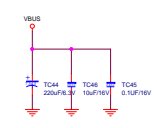
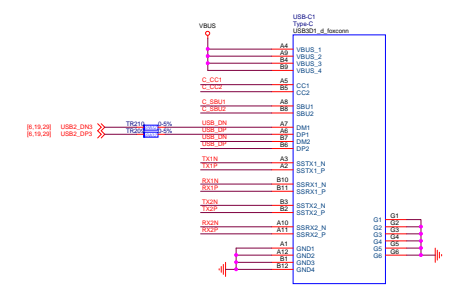
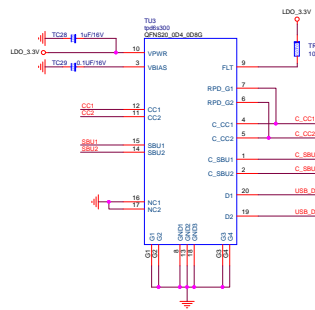
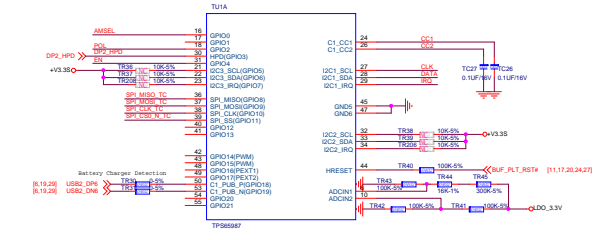
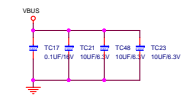
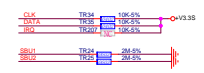
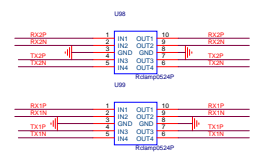

2023年10月20日 09:28:08

Table 5. Boot Mode Pin Strapping

SPL_MISO	ADCIN1 DIV = R2/(R1+R2) ^{1/2}	DIV MIN	DIV MAX	Dead Battery Mode	Device Configuration
1	0.50	0.15	0.15	BP_NoResponse	Safe Configuration
1	0.20	0.25	0.25	BP_WaitForV3_Internal	Safe Configuration
1	0.30	0.35	0.35	BP_ECWait_Internal	Infinite Wait
1	0.40	0.45	0.45	BP_WaitForV3_External	Safe Configuration
1	0.50	0.55	0.55	BP_ECWait_External	Infinite Wait
1	0.60	1.00	1.00	BP_NoWait	Safe Configuration
0	0.10	0.15	0.15	BP_NoResponse	Configuration 1
0	0.20	0.25	0.25	BP_NoWait	Configuration 2
0	0.30	0.35	0.35	BP_ECWait_Internal	Infinite Wait
0	0.40	0.45	0.45	BP_NoWait	Configuration 3
0	0.50	0.55	0.55	BP_ECWait_External	Infinite Wait
0	0.60	0.65	0.65	BP_NoWait	Configuration 4
0	0.70	0.75	0.75	BP_NoWait	Reserved
0	0.80	0.85	0.85	BP_NoResponse	Reserved
0	0.90	1.00	1.00	BP_NoWait	Configuration 5

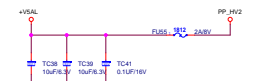
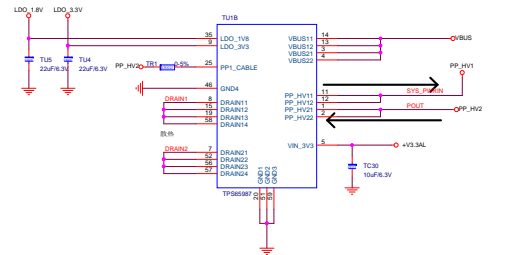
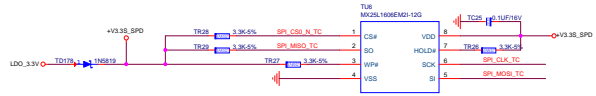

NOTE
It is recommended to use PPHV1 as a sink path and PPHV2 as a source path.