

实际输入电压：12V

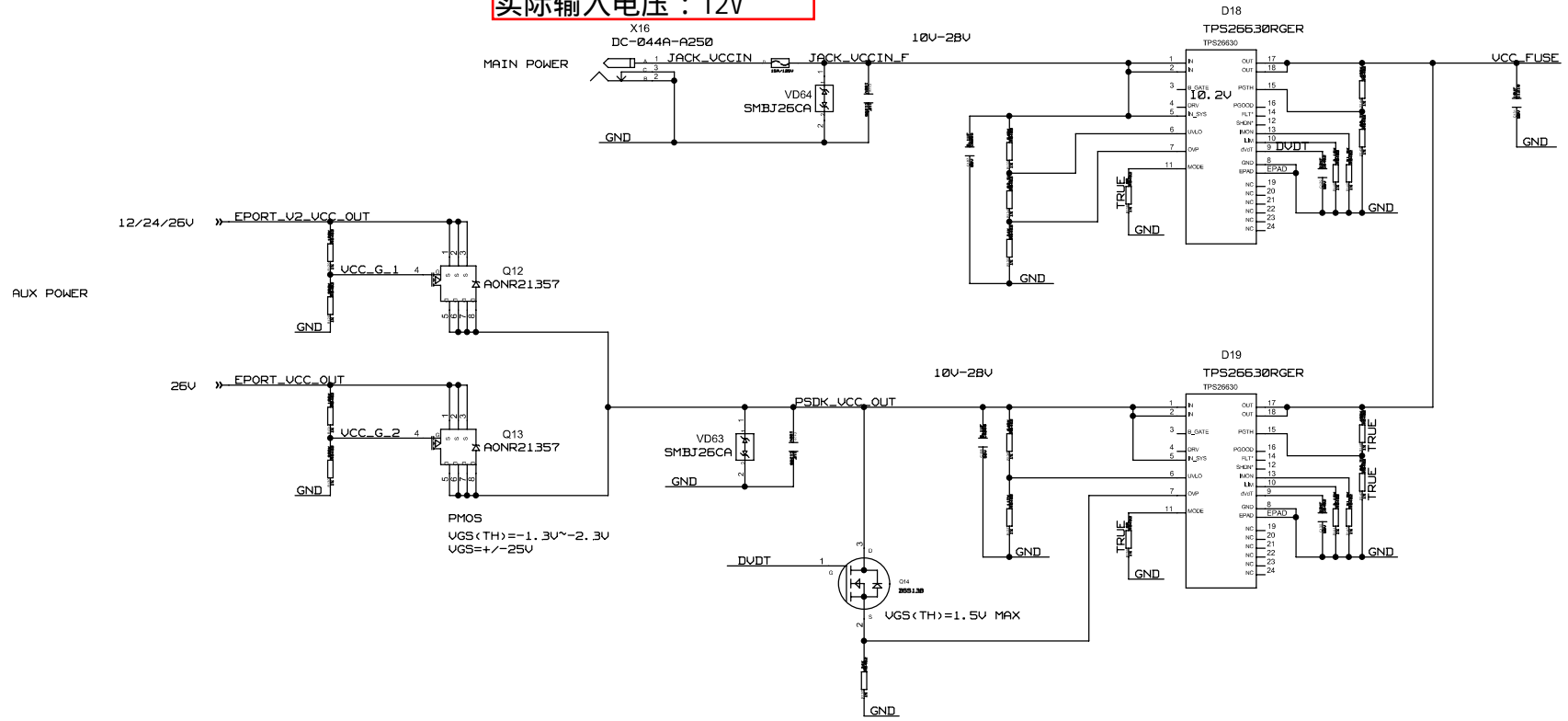

NO INPUT REVERSE POLARTIY PROTECTION  
NO REVERSE CURRENT BLOCKING

ORING & EFUSE

Thu Oct 23 10:15:19 2025

PENG CHENG LABORATORY

THIS DOCUMENT CONTAINS INFORMATION PROPRIETARY TO PENG CHENG LABORATORY (PCL). USE OR DISCLOSURE WITHOUT THE WRITTEN PERMISSION OF PCL IS FORBIDDEN.

SIZE	REV.	DRAWING TITLE	
C	250000	ASLW	
AUTHOR	LI CONG	PAGE NAME	SHEET
		?	14 OF 18



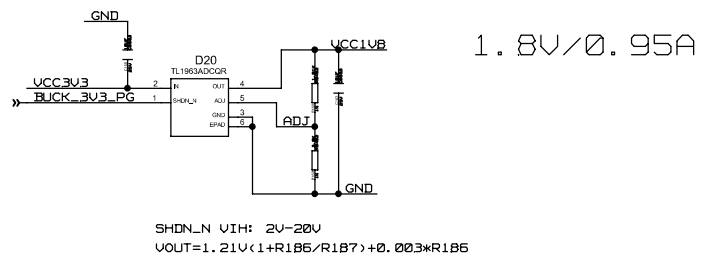
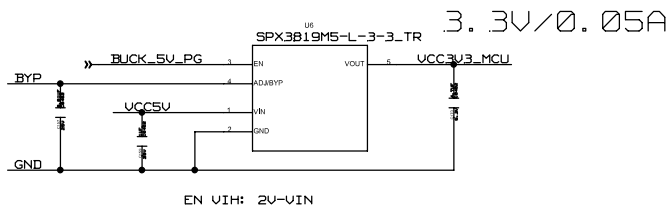
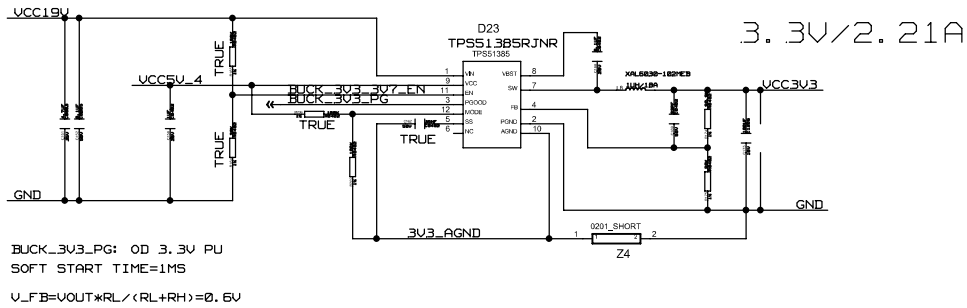
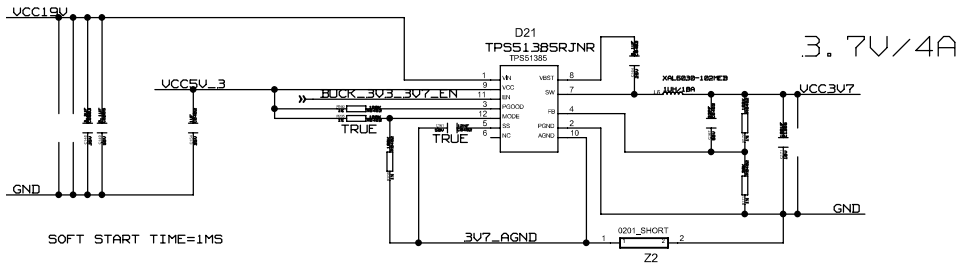
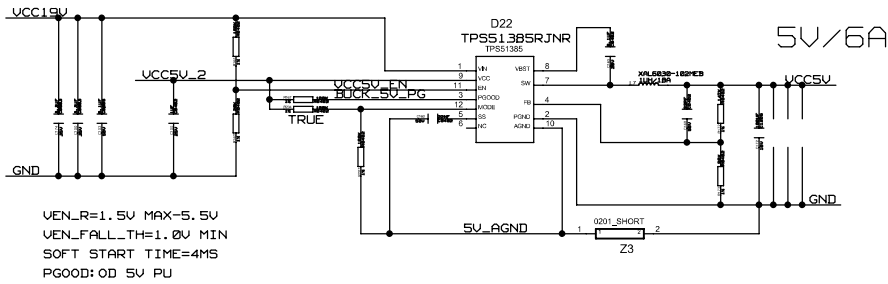

### UCC3V3 RAIL DISCHARGE

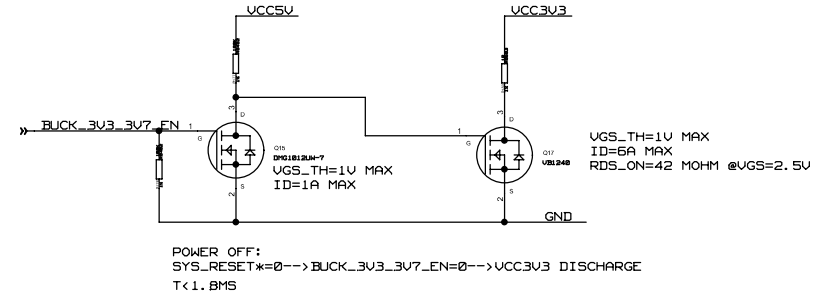

### UCC1V8 RAIL DISCHARGE

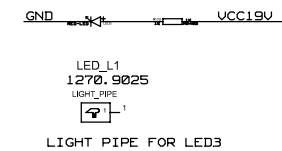
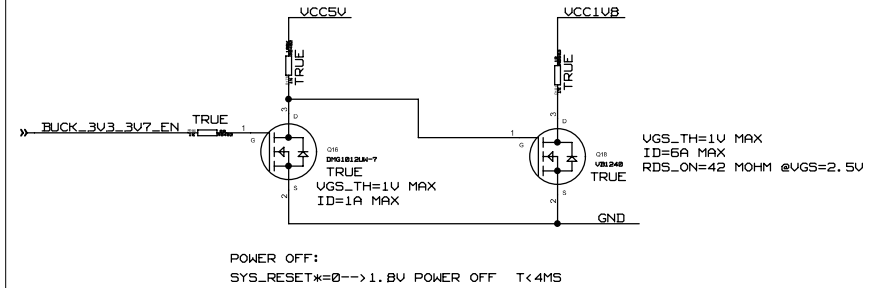

Thu Oct 23 10:15:19 2025

### PENG CHENG LABORATORY

THIS DOCUMENT CONTAINS INFORMATION PROPRIETARY TO PENG CHENG LABORATORY (PCL). USE OR DISCLOSURE WITHOUT THE WRITTEN PERMISSION OF PCL IS FORBIDDEN.

SIZE	REV.	DRAWING TITLE	
C	250800	ASLW	
AUTHOR	LI CONG	PAGE NAME	SHEET
		?	15OF18