

# CC1310 Skyworks 433MHz PA Reference Design

Albin Zhang and Richard Wallace

## ABSTRACT

The frequency range 426 MHz - 435 MHz is designated for ISM applications in several countries. This frequency range is commonly known as the 433 MHz band. Each country has their specific frequency band range and the China ISM band defined by SRRC is 430 MHz - 432 MHz and 433.00 MHz - 434.79 MHz.

CC1310 reference design [8] operates from 420 MHz to 510 MHz with 15 dBm output power. If higher output power is required in the 433 MHz band, TI provides a reference design [3] with Skyworks Solutions. The combination of CC1310 wireless MCU [2] and SKY66115-11 FEM [4], addresses customers' needs for easy-to-use, long-range, low-power and low-cost solutions serving applications across the Internet of Things (IoT). The reference design covered in this application report can support up to +20 dBm TX power with high power efficiency at 433 MHz.

## Contents

1	Introduction .....	2
2	Design .....	2
3	Measurement Results .....	8
4	Summary .....	11
5	References .....	11

## List of Figures

1	CC1310EM-SKY66115-4051 Board.....	2
2	CC1310 Block Diagram .....	3
3	Schematic - CC1310EM-SKY66115-4051 Rev2_0_x .....	4
4	CC1310EM-SKY66115-4051 Layout.....	5
5	DIO Configuration in SmartRF Studio 7 .....	6
6	Tx Mode Configuration.....	7
7	Rx mode configuration .....	8
8	Matching of the Antenna With ANT1 and ANT2 Components .....	10
9	Antenna Bandwidth at VSWR: 2 .....	10

## List of Tables

1	SKY66115-11 Truth Table.....	6
2	Conducted Output Power and Harmonics, 3.3 V .....	8
3	TX Output Power, Current Consumption vs. Power Table, 3.3 V .....	9

## Trademarks

SmartRF is a trademark of Texas Instruments.  
 Cortex is a registered trademark of ARM Limited.

## 1 Introduction

The design covered in this application note is based on the CC1310 from the CC13xx family. It provides a range extension solution with the FEM from Skyworks (SKY66115-11) and a compact on-board helical PCB antenna.

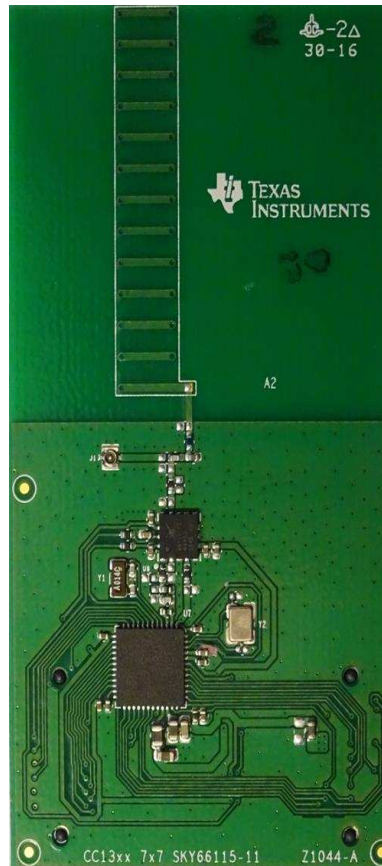

**Figure 1. CC1310EM-SKY66115-4051 Board**

## 2 Design

When designing a wireless system, the maximum range between the transmitter and receiver is one of the most important parameters that will dominate the system configuration and installation. In the AMR system, the range is critical so that all households' meters can be read otherwise this must be done manually or adding more concentrators, which is expensive. To achieve a long range the output power can be increased to the maximum limit specified by the regulations and the data rate reduced as much as possible for the application. One of the efficient approaches to increase range is to increase the TX power.

### 2.1 CC1310

The CC1310 has been specifically designed for long range, city-wide low power networks. This is used in home automation, building automation and outdoor wide-area networks. The main advantages of CC1310 are high sensitivity (-124 dBm with a 0.625 kbps data rate), strong co-existence (up to 80 dB blocking), lowest power consumption (61  $\mu$ A / MHz ARM Cortex M3).

CC1310 can be basically split into four low-power sections as shown in [Figure 2](#):

- Main CPU with Cortex®-M3
- RF Core with radio controller. The RF core is a highly flexible and capable radio system that interfaces the analog RF and base-band circuits, handles data to and from the system side, and assembles the information bits in a given packet structure.

- General Peripherals
- Sensor Controller

For more in-depth information on the CC1310, see the *CC1310 SimpleLink™ Ultra-Low-Power Sub-1 GHz Wireless MCU Data Sheet (SWRS181)*.

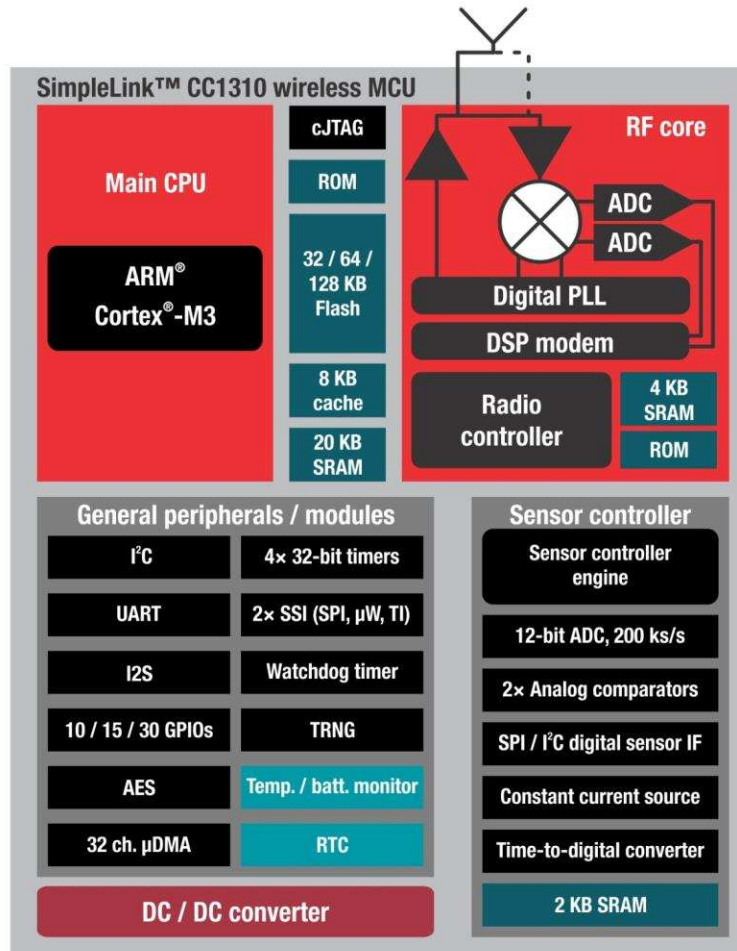

Figure 2. CC1310 Block Diagram

## 2.2 Schematic

The RF core of CC1310 is highly configurable and the radio front-end can be set to differential or single ended. With a differential output configuration, the maximum output is 14 dBm. With a single ended output, the maximum output is 11 dBm. Several customers have requested an output power up to 20dBm, the CC1310 transmitter was configured as a single ended port (RF\_P set to Tx) connected to an external FEM with an integrated amplifier, see [Figure 3](#). If an output power of 14 dBm is sufficient then the standard reference design for 420 MHz to 510 MHz can be used [\[8\]](#).

The schematic shown in [Figure 3](#) is a general schematic (Rev 2.0.x) to cover the ISM frequency bands from 400 MHz to 510 MHz; the BOM is specified for three different ISM frequency bands:

- 470 MHz – 510 MHz: BOM - CC1310EM-SKY66115-4051 Rev 2.0.1
- 420 MHz – 440 MHz: BOM - CC1310EM-SKY66115-4051 Rev 2.0.2
- 400 MHz – 420 MHz: BOM - CC1310EM-SKY66115-4051 Rev 2.0.3

The FEM used is from Skyworks (SKY66115-11). The SKY66115-11 consists of an amplifier and a switch contained in the package. It also includes a shutdown mode to minimize power consumption. The transmit path contains an amplifier optimized for saturated performance. SKY66115-11 is internally matched for CC1310, which enables optimum transmit output power and efficiency for 50 Ω load impedance. The transmit path passes through a low-pass filter before being entering to one side of the SPDT switch. The receive path has a bypass function from the other side of the SPDT switch.

The reference design [3] shown in Figure 3 is based upon 3.3 V supply voltage. Two RF output options are available. Mounting C72, the RF path is routed to the RF connector (J1) that allows an external antenna or conductive RF testing. Mounting C63, connects the compact PCB antenna. ANT1, ANT2 and ANT3 compose of the antenna matching circuit.

A low-pass filter (C484, C485, C486 and L332) is incorporated on the ANT port to provide additional filtering and/or limit unwanted signals from entering the receive path.

CC1310 can support several RF port options, described in the wiki page [7]. For better Rx sensitivity, the reference design adopts a single-end, external-bias RF front-end design. L1 is used for the external bias circuit. C11, L11 and L12 compose a matching circuit to optimize the RX sensitivity.

The reference design [3] utilizes noise decoupling on the power and control lines of the SKY66115-11.

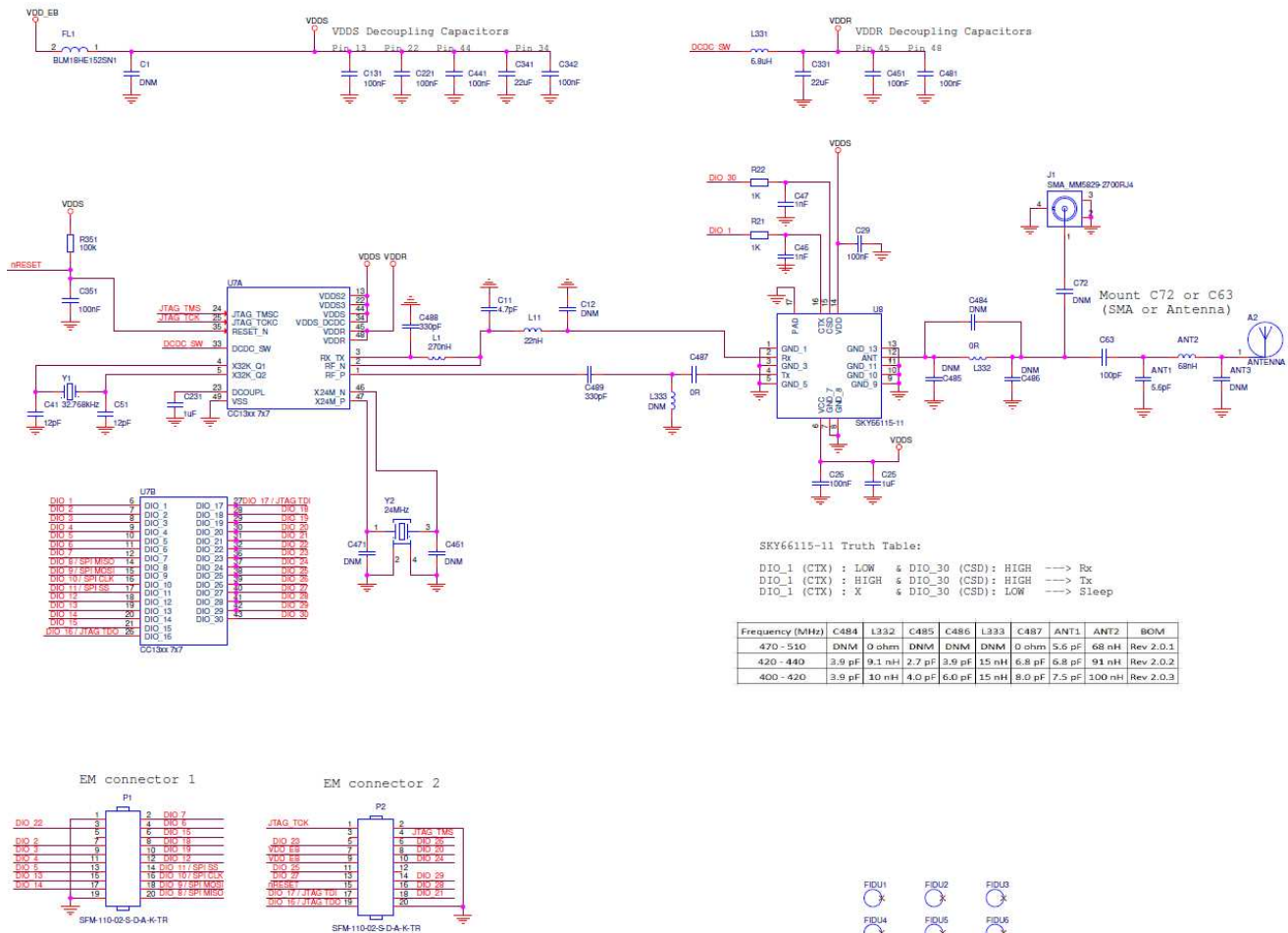
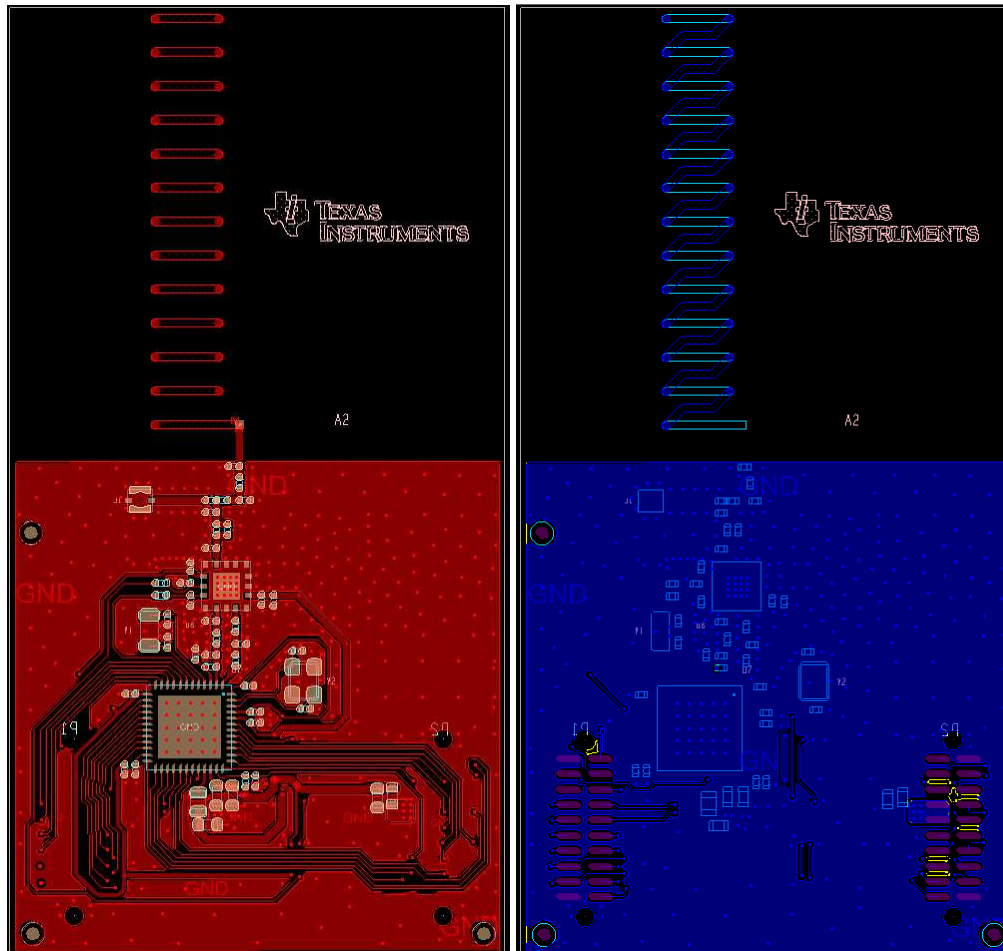

Figure 3. Schematic - CC1310EM-SKY66115-4051 Rev2\_0\_x

## 2.3 Layout

The design [3] is based on a 0.8 mm thick, two-layer PCB. The top layer and bottom layer are shown in Figure 4. All components are positioned on the top layer apart from the evaluation module (EM) connectors. The CC1310EM-SKY66115-4051 is based upon the 7x7 QFN package. The RF frond-end design can be re-used for 5x5 QFN and 4x4 QFN packages.

A PCB helical antenna is incorporated in the EM design. The antenna is routed on both the top and bottom layers. It is important to incorporate the matching components (ANT1, ANT2 and ANT3) as well if the antenna structure is to be copied to another design. Changing the PCB thickness will change the resonance of the antenna and this would require new antenna matching values for ANT1 and ANT2 (ANT3: DNM).



**Figure 4. CC1310EM-SKY66115-4051 Layout**

The top view is shown on the left side; the bottom view is shown on the right side.

## 2.4 SmartRF™ Studio

To evaluate the reference design it is recommended to use the EM on the SmartRF06EB with SmartRF Studio software. The supported functions are continuously being updated and the software can be downloaded [6].

With SmartRF studio 7 (version 2.4.3), new features have been added to support 433 MHz – 510 MHz reference designs.

- Default recommended setting on 430-510MHz band.
- DIOs configuration based on the truth table of the FEM.
- RF front-end mode configuration.

For more information on SmartRF Studio7, see <http://www.ti.com/tool/smartrfm-studio>. Figure 5, Figure 6 and Figure 7 illustrate how to configure the CC1310EM-SKY66115-4051 board.

### 2.4.1 DIO Configuration

Based on the truth table of the SKY66115-11 shown in Table 1, SmartRF Studio should have the DIO configured as shown in Figure 5.

**Table 1. SKY66115-11 Truth Table**

```
DIO_1 (CTX) : LOW & DIO_30 (CSD) : HIGH ----> Rx
DIO_1 (CTX) : HIGH & DIO_30 (CSD) : HIGH ----> Tx
DIO_1 (CTX) : X & DIO_30 (CSD) : LOW ----> Sleep
```

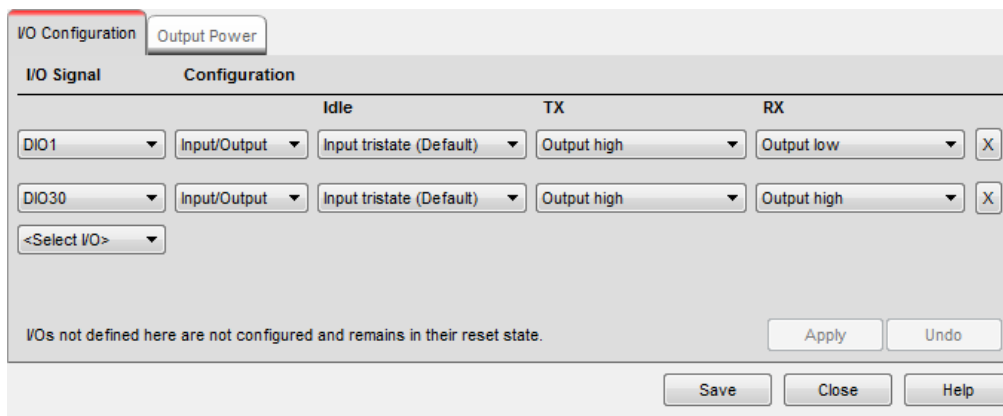

**Figure 5. DIO Configuration in SmartRF Studio 7**



### 2.4.2 RF Front-End Configuration

Figure 6 and Figure 7 show the configuration of Tx and Rx modes separately. This is configured in the CMD\_PROP\_RADIO\_DIV\_SE radio operation commands.

For the Tx path configuration shown in Figure 6, RF\_P is set to single-end option. The txpower parameters should also be configured based on Table 3.

For the Rx path shown in Figure 7, RF\_N is set to single-end option.

Radio Operation Commands	Value
▶ CMD_FS	
▶ CMD_PROP_TX	
▼ CMD_PROP_RADIO_DIV_SETUP	
commandNo	0x3807
status	0x0000
pNextOp	0x00000000
startTime	0x00000000
startTrigger	0x00
condition	0x01
modulation	0x0321
symbolRate	0x0080000F
rxBw	0x24
preampConf	0x04
formatConf	0x00A0
config	0x0009
txPower	0x1CC7
pRegOverride	0x00000000
centerFreq	0x0364
intFreq	0x8000
loDivider	0x05

Bit Fields	Value
frontEndMode [0..2]	0x 1
biasMode [3..3]	0x 1
analogCfgMode [4..9]	0x 0
bNoFsPowerUp [10..10]	0x 0

Figure 6. Tx Mode Configuration

Radio Operation Commands		Value
▷	CMD_FS	
▷	CMD_PROP_TX	
▽	CMD_PROP_RADIO_DIV_SETUP	
	commandNo	0x3807
	status	0x0000
	pNextOp	0x00000000
	startTime	0x00000000
	startTrigger	0x00
	condition	0x01
	modulation	0x0321
	symbolRate	0x0080000F
	rxBw	0x24
	preamConf	0x04
	formatConf	0x00A0
	config	0x000A
	txPower	0x1CC7
	pRegOverride	0x00000000
	centerFreq	0x0364
	intFreq	0x8000
	loDivider	0x05

Bit Fields		Value
frontEndMode	[0..2]	0x 2
biasMode	[3..3]	0x 1
analogCfgMode	[4..9]	0x 0
bNoFsPowerUp	[10..10]	0x 0

**Figure 7. Rx mode configuration**

### 3 Measurement Results

All measurements results were performed on the CC1310EM-SKY66115-4051 at 433 MHz (BOM Rev 2.0.2) EM mounted on the SmartRF06EB. Software control is based on SmartRF Studio 2.4.3.

#### 3.1 Tx Output Power and Harmonics

The output power was measured at 433.92 MHz. The harmonics were measured up to the 10th harmonic. The txpower register is set to 0x1CC7.

**Table 2. Conducted Output Power and Harmonics, 3.3 V**

Harmonics	fc	2fc	3fc	4fc	5fc	6fc	7fc	8fc	9fc	10fc
Frequency (MHz)	433.92	867.84	1301.76	1735.68	2169.6	2603.52	3037.44	3471.36	3905.28	4339.2
Level (dBm)	20.5	-37	-49	-55	-55	-55	-55	-55	-55	-55



### 3.2 Tx Output Power Dynamic Range and Current Consumption

Output power and current consumption were measured across the power table at 433.92 MHz. The average results are shown in [Table 3](#).

In the CMD\_PROP\_RADIO\_DIV\_SETUP, the power can be configured in the txpower register, which is shown in [Figure 6](#).

**Table 3. TX Output Power, Current Consumption vs. Power Table, 3.3 V**

Power Table	0x08C0	0x0041	0x10C3	0x1043	0x14C4	0x18C5	0x18C6	0x1CC7	
Output power	12.3	16.3	18	18.9	19.3	19.6	19.8	20	dBm
Current consumption	52	62.8	71.4	75.9	78.1	79.7	81.6	82.4	mA

The SKY66115-11 maximum input power rating on the PIN\_TX is limited to 10dBm. CC1310 should limit the TX Power control IB bit of txpower register below 0x07.

### 3.3 Rx Current Consumption

The static Rx current consumption was measured at 6.3 mA with 3.3 V power supply.

### 3.4 Sensitivity

The sensitivity was measured with 50 kbps datarate setting on CC1310EM-SKY66115-4051 at 433 MHz (BOM Rev 2.0.2) to -106.4 dBm during normal temperature and 3.3 V power supply.

If the data rate is reduced from 50 kbps and Long Range Mode utilized, then the following sensitivity levels can be achieved on the on CC1310EM-SKY66115-4051 at 433 MHz (BOM Rev 2.0.2) Ref Design:

- 5 kbps sensitivity: -117 dBm
- 2.5 kbps sensitivity: -119 dBm
- 1.25 kbps sensitivity: -120 dBm
- 0.625 kbps sensitivity: -121 dBm

### 3.5 Antenna Design

The PCB helical antenna shown in [Figure 4](#) has been matched to 433.92 MHz with ANT 1: 6.8 pF and ANT2: 91 nH. For more information, see [Figure 8](#). The antenna is matched for the complete band of 470 MHz – 510 MHz. For more information, see [Figure 8](#) and [Figure 9](#).

This antenna design, matching tuning and testing results are based on the CC1310EM-SKY66115-4051 board at 433 MHz (BOM Rev 2.0.2) plugging on the SmartRF06EB board with the free space environment. In antenna design theory, some of the nearby materials will impact the antenna performances, for example, grounded conductor, plastic/rubber cases, and so forth. For a realistic product antenna design, it is necessary to consider the mechanical case impacts and do proper tuning.

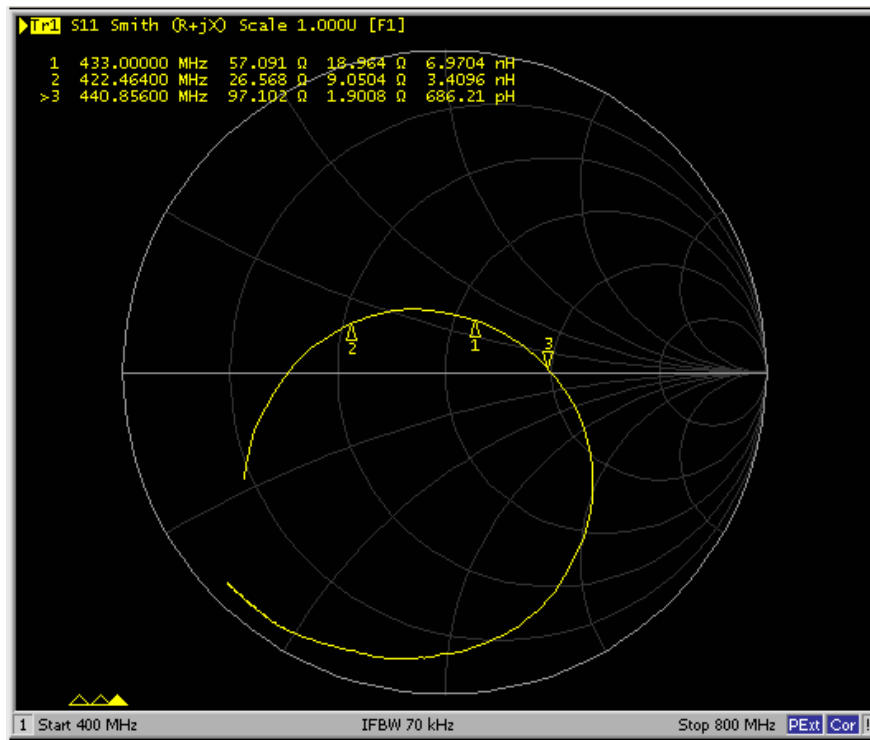

Figure 8. Matching of the Antenna With ANT1 and ANT2 Components

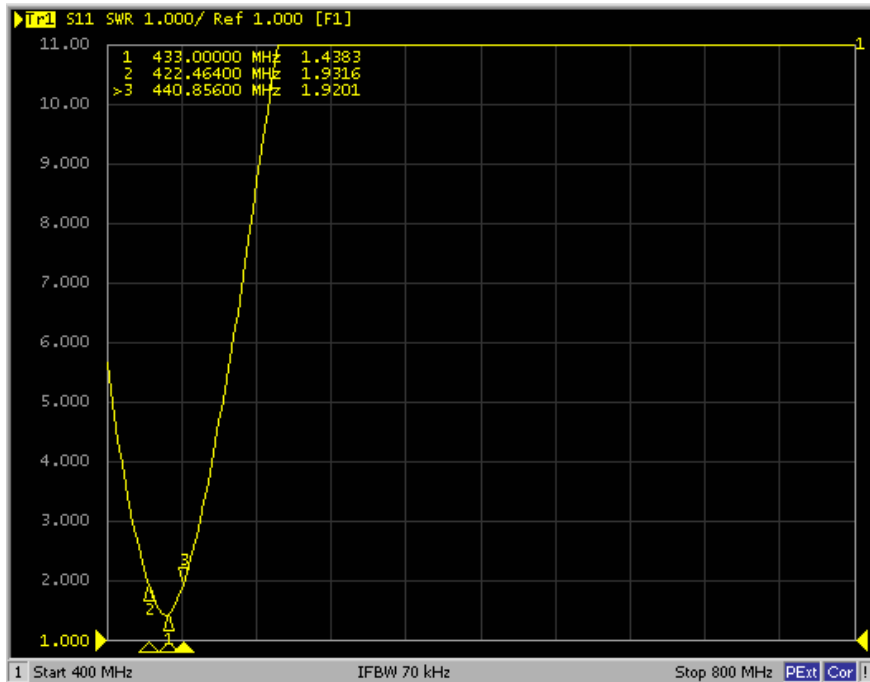

Figure 9. Antenna Bandwidth at VSWR: 2

## 4 Summary

The CC1310EM-SKY66115-4051 reference design at 433 MHz (BOM Rev 2.0.2) is a low cost, easy-to-use, high efficiency solution with 20 dBm output power for 3.3 V supply. Tx current consumption at 20 dBm is approximately 82 mA. The antenna is also integrated into the PCB that provides a compact, costless antenna solution.

## 5 References

1. *Achieving Optimum Radio Range* ([SWRA479](#))
2. *CC1310 SimpleLink™ Ultra-Low-Power Sub-1 GHz Wireless MCU Data Sheet* ([SWRS181](#))
3. *CC1310EM-SKY66115-4051 Reference Design (Rev: 2.0.x)* ([SWRC334](#))
4. [SKY66115 -11 Data Sheet](#)
5. *Antenna Quick Guide* ([SWRA351](#))
6. [SmartRF Studio Download](#)
7. [CC1310 Front-end Configurations Wiki page](#)
8. [CC13xxEM-7XD-4251 Rev1\\_1\\_1](#)

## IMPORTANT NOTICE FOR TI DESIGN INFORMATION AND RESOURCES

Texas Instruments Incorporated ("TI") technical, application or other design advice, services or information, including, but not limited to, reference designs and materials relating to evaluation modules, (collectively, "TI Resources") are intended to assist designers who are developing applications that incorporate TI products; by downloading, accessing or using any particular TI Resource in any way, you (individually or, if you are acting on behalf of a company, your company) agree to use it solely for this purpose and subject to the terms of this Notice.

TI's provision of TI Resources does not expand or otherwise alter TI's applicable published warranties or warranty disclaimers for TI products, and no additional obligations or liabilities arise from TI providing such TI Resources. TI reserves the right to make corrections, enhancements, improvements and other changes to its TI Resources.

You understand and agree that you remain responsible for using your independent analysis, evaluation and judgment in designing your applications and that you have full and exclusive responsibility to assure the safety of your applications and compliance of your applications (and of all TI products used in or for your applications) with all applicable regulations, laws and other applicable requirements. You represent that, with respect to your applications, you have all the necessary expertise to create and implement safeguards that (1) anticipate dangerous consequences of failures, (2) monitor failures and their consequences, and (3) lessen the likelihood of failures that might cause harm and take appropriate actions. You agree that prior to using or distributing any applications that include TI products, you will thoroughly test such applications and the functionality of such TI products as used in such applications. TI has not conducted any testing other than that specifically described in the published documentation for a particular TI Resource.

You are authorized to use, copy and modify any individual TI Resource only in connection with the development of applications that include the TI product(s) identified in such TI Resource. NO OTHER LICENSE, EXPRESS OR IMPLIED, BY ESTOPPEL OR OTHERWISE TO ANY OTHER TI INTELLECTUAL PROPERTY RIGHT, AND NO LICENSE TO ANY TECHNOLOGY OR INTELLECTUAL PROPERTY RIGHT OF TI OR ANY THIRD PARTY IS GRANTED HEREIN, including but not limited to any patent right, copyright, mask work right, or other intellectual property right relating to any combination, machine, or process in which TI products or services are used. Information regarding or referencing third-party products or services does not constitute a license to use such products or services, or a warranty or endorsement thereof. Use of TI Resources may require a license from a third party under the patents or other intellectual property of the third party, or a license from TI under the patents or other intellectual property of TI.

TI RESOURCES ARE PROVIDED "AS IS" AND WITH ALL FAULTS. TI DISCLAIMS ALL OTHER WARRANTIES OR REPRESENTATIONS, EXPRESS OR IMPLIED, REGARDING TI RESOURCES OR USE THEREOF, INCLUDING BUT NOT LIMITED TO ACCURACY OR COMPLETENESS, TITLE, ANY EPIDEMIC FAILURE WARRANTY AND ANY IMPLIED WARRANTIES OF MERCHANTABILITY, FITNESS FOR A PARTICULAR PURPOSE, AND NON-INFRINGEMENT OF ANY THIRD PARTY INTELLECTUAL PROPERTY RIGHTS.

TI SHALL NOT BE LIABLE FOR AND SHALL NOT DEFEND OR INDEMNIFY YOU AGAINST ANY CLAIM, INCLUDING BUT NOT LIMITED TO ANY INFRINGEMENT CLAIM THAT RELATES TO OR IS BASED ON ANY COMBINATION OF PRODUCTS EVEN IF DESCRIBED IN TI RESOURCES OR OTHERWISE. IN NO EVENT SHALL TI BE LIABLE FOR ANY ACTUAL, DIRECT, SPECIAL, COLLATERAL, INDIRECT, PUNITIVE, INCIDENTAL, CONSEQUENTIAL OR EXEMPLARY DAMAGES IN CONNECTION WITH OR ARISING OUT OF TI RESOURCES OR USE THEREOF, AND REGARDLESS OF WHETHER TI HAS BEEN ADVISED OF THE POSSIBILITY OF SUCH DAMAGES.

You agree to fully indemnify TI and its representatives against any damages, costs, losses, and/or liabilities arising out of your non-compliance with the terms and provisions of this Notice.

This Notice applies to TI Resources. Additional terms apply to the use and purchase of certain types of materials, TI products and services. These include; without limitation, TI's standard terms for semiconductor products (<http://www.ti.com/sc/docs/stdterms.htm>), [evaluation modules](#), and [samples](http://www.ti.com/sc/docs/sampterm.htm) (<http://www.ti.com/sc/docs/sampterm.htm>).

Mailing Address: Texas Instruments, Post Office Box 655303, Dallas, Texas 75265  
Copyright © 2017, Texas Instruments Incorporated