

交直流变换多功能控制板

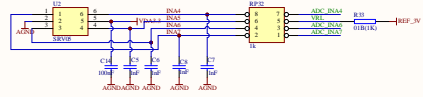

瞬态抑制二极管 (TVS) 是浪涌保护器件

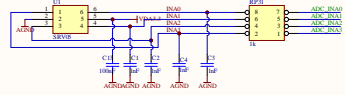
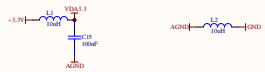

外扩存储器E2PROM

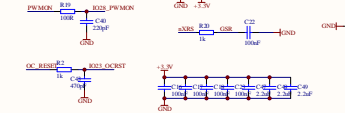
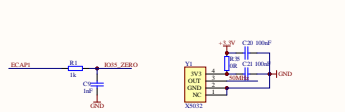

注: REF_3V在实际电路中由-wv对应的e5:AD01是10k4, 超过此值就会保护动作

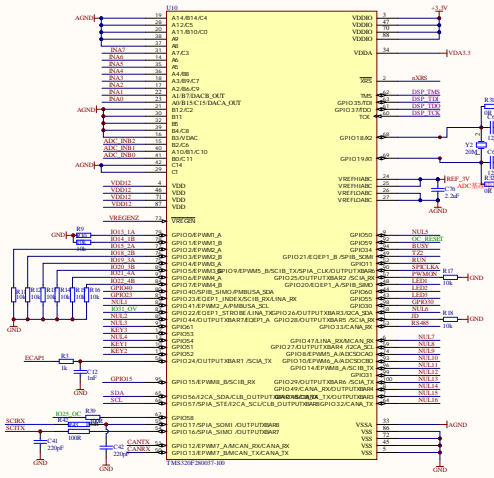
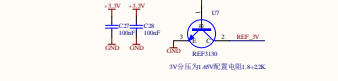
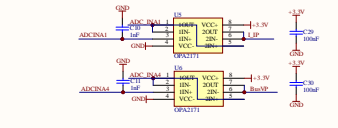
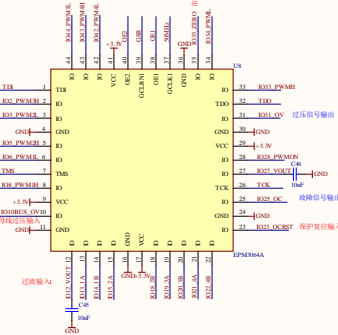

F28035片内存储器AM18K*16位, FLASH 64K*16位

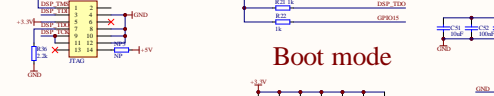

JTAG下载

电源滤波

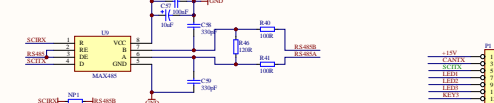
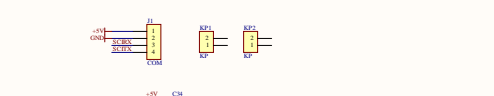

RS485

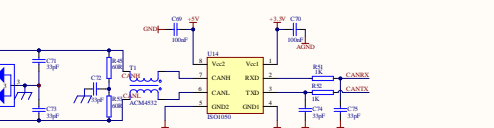

CAN

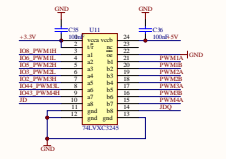

PWM接口

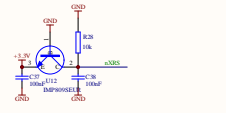

复位电路



核心板接口

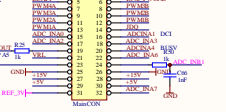

电源管理



电源管理

Ver	Number	Revision
A1		
Drawn	0-20-2021	ADC-F28035M1-21-30
File	C:\Users\ADMINI~1\Desktop	

