



# PRODUCT SPECIFICATION

**Doc. Number:**

- Tentative Specification
- Preliminary Specification
- Approval Specification

**MODEL NO.: DJ090IA**  
**SUFFIX: 01A**

<b>Customer:</b>	
<b>APPROVED BY</b>	<b>SIGNATURE</b>
<b>Name / Title</b>	
Note :	
Only for reference	
Please return 1 copy for your confirmation with your signature and comments	

Approved By	Checked By	Prepared By
Henry.Chien	WeiLun.Liao	Jessie.Lin



# PRODUCT SPECIFICATION

## REVISION HISTORY

Version	Date	Page	Description
0.0	Dec,2,2015	All	Spec Ver.0.0 was first issued
1.0	Jun.13.2016	Page1 Page6	Modify "Backlight power consumption" "Panel power consumption" Modify "Voltage for LED backlight(Max.)" "Current for LED backlight(Typ.)"
2.0	Aug.31.2016	Page1 Page3 Page5 Page6 Page7 Page9 Page14 Page17 Page22	Modify "Backlight power consumption" "Weight" Modify Pin Definition: No.27(NTC GND), No35(NTC) Modify "LED Forward Current". Add "Note 5-1,2,3,4" Modify "Voltage for LED backlight" "Current for LED backlight" "Note 9" Add "Backlight NTC Resistor" " De-rating diagram" "Power Sequence" Modify "AC Electrical Characteristics" Modify "Viewing angle" "Response time" "Contrast ratio". Add "NTSC" Add Temperature Definition: "Ta" "Tp" Modify "Unit Weight": LCM Module, EPO Box, Carton, Total weight
2.1	Sep.7.2016	Page20	Modify "Mechanical Drawing"
2.2	Apr.11.2017	Page2 Page6 Page7 Page9 Page12	Modify " Pin Assignment" Add "Current Consumption" Add "LED schematic" Modify "Power off" Modify "Termination Resistor"
2.3	Jun.2.2017	Page21	Modify "Mechanical Drawing"

## Contents

<b>1. General Specifications</b> .....	<b>1</b>
<b>2. Pin Assignment</b> .....	<b>2</b>
<b>3. Operation Specifications</b> .....	<b>5</b>
3.1. Absolute Maximum Ratings .....	5
3.1.1. Typical Operation Conditions .....	6
3.1.2. Current Consumption .....	6
3.1.3. Backlight Driving Conditions .....	7
3.1.4. Backlight NTC Resistor.....	7
3.1.5. De-rating diagram.....	8
3.2. Power Sequence .....	8
3.3. Timing Characteristics .....	10
3.3.1. AC Electrical Characteristics .....	10
3.3.2. Input Clock and Data Timing Diagram .....	11
3.3.3. DC Electrical Characteristics .....	12
3.3.4. Timing .....	13
3.3.5. Data Input Format.....	13
3.3.6. Reset timing.....	14
<b>4. Optical Specifications</b> .....	<b>15</b>
<b>5. Reliability Test Items</b> .....	<b>18</b>
<b>6. General Precautions</b> .....	<b>20</b>
6.1. Safety.....	20
6.2. Handling .....	20
6.3. Static Electricity .....	20
6.4. Storage.....	20
6.5. Cleaning .....	20
<b>7. Mechanical Drawing</b> .....	<b>21</b>
<b>8. Package Drawing</b> .....	<b>23</b>
8.1. Packaging Material Table.....	23
8.2. Packaging Quantity.....	23
8.3. Packaging Drawing.....	24
8.4. Shipping Drawing.....	25

## 1. General Specifications

No.	Item	Specification	Remark
1	LCD size	9.0 inch (Diagonal)	
2	Driver element	a-Si TFT active matrix	
3	Resolution	1280 × 3(RGB) × 720	
4	Display mode	Normally Black, Transmissive, AAS	
5	Dot pitch	0.0518(W) × 0.1554(H) mm	
6	Active area	198.912(W) × 111.888(H) mm	
7	Module size	211.2(W) × 125.3(H) × 5.9(D) mm	Note 1
8	Surface treatment	Anti-Glare	
9	Color arrangement	RGB-stripe	
10	Interface	1-port LVDS (DE mode only)	
11	Backlight power consumption	5.81W (Max.)	
12	Panel power consumption	1.2W (Max.)	
13	Weight	230g (Max.)	

Note 1: Refer to Mechanical Drawing.



# PRODUCT SPECIFICATION

## 2. Pin Assignment

PCBa connector is used for the module electronics interface. The recommended model is 20647-040E-01 manufactured by I-PEX.

Pin No.	Symbol	I/O	Pulled Internally (Note3)	Function	Remark
1	MODE	-	L	DE mode only. Normally display please set it Low.	
2	VDD	Power		External main and I/O power supply ; Power3V3	Note 2
3	VDD	Power		External main and I/O power supply : Power3V3	Note 2
4	BISTEN	-	L	BIST disable. Normally display please set it Low.	
5	RESET	Input	H	Global reset pin	Note 2
6	STBYB	Input	H	Standby mode setting pin	Note 2
7	GND	Power		Ground	
8	RXIN0-	Input		LVDS data 0-	
9	RXIN0+	Input		LVDS data 0+	
10	GND	Power		Ground	
11	RXIN01-	Input		LVDS data 1-	
12	RXIN01+	Input		LVDS data 1+	
13	GND	Power		Ground	
14	RXCLKIN-	Input		LVDS clk -	
15	RXCLKIN+	Input		LVDS clk +	
16	GND	Power		Ground	
17	RXIN02-	Input		LVDS data 2-	
18	RXIN02+	Input		LVDS data 2+	
19	GND	Power		Ground	
20	RXIN03-	Input		LVDS data 3-	
21	RXIN03+	Input		LVDS data 3+	
22	GND	Power		Ground	
23	SCL	-	L	Serial Interface clock input. If no use please connect to ground.	
24	SDA	-	L	Serial Interface address and data input/output. If no use please connect to ground.	



# PRODUCT SPECIFICATION

25	GND	Power		Ground
26	CSB	-	H	Serial Interface chip enable signal. If no use please set it High to disable.
27	NTC GND	Power		LED Driver for NTC Function, If not use please keep floating or connect to ground.
28	SELB(DINT)	Input	H	Input Input data format selection DINT = 1 : 8-bit (Default) DINT = 0 : 6-bit
29	FCS	-	H	Function control by Hardware. For DINT, RL, TB, BIST control by main board please set it High.
30	GND	Power		Ground
31	LED-	Power		Negative backlight voltage
32	LED-	Power		Negative backlight voltage
33	L/R	Input	H	Horizontal shift direction (source output) selection. RL = 1: Left -> Right (Default) RL = 0: Right -> Left
34	U/D	Input	H	Vertical shift direction (gate output) selection. TB = 1: Top ->Bottom (Default) TB = 0: Bottom ->Top
35	NTC	Input		LED Driver for NTC Function, If not use please keep floating or connect to ground.
36	ATREN	-	H	Auto reload OTP in operation mode every 64 frames.
37	OTP_VDD	-	H	Keep floating or connect to VDD.
38	NC	-		Keep floating or connector to ground.
39	LED+	Power		Positive backlight voltage
40	LED+	Power		Positive backlight voltage

Note 2: Please follow "3.2 power sequence"

Note 3: Typical internal pull low / high resistor is 350 kΩ

Note 4: Definition of scanning direction.  
Refer to the figure as below:

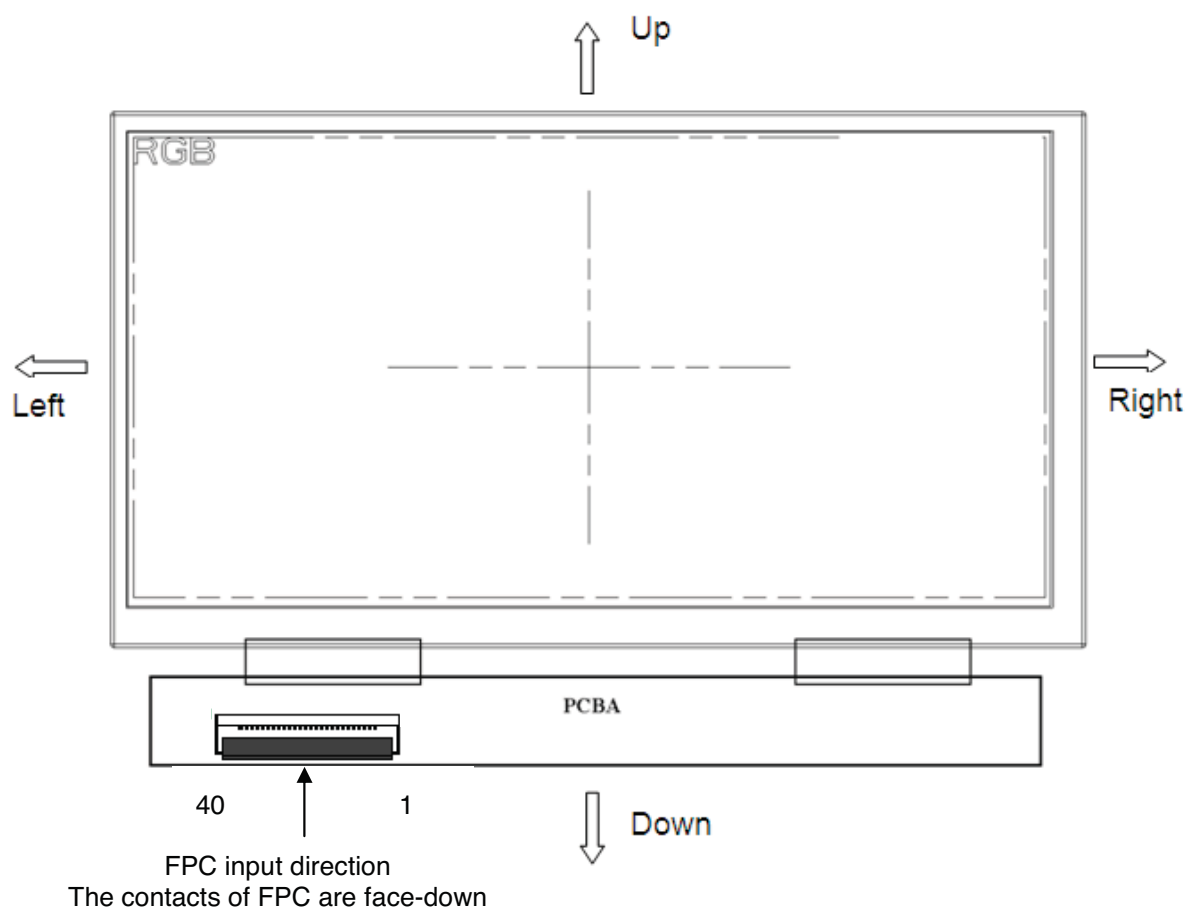

## 3. Operation Specifications

### 3.1. Absolute Maximum Ratings

(GND=0V, Note 5)

Item	Symbol	Values		Unit	Remark
		Min.	Max.		
Power voltage	$V_{DD}$	-0.3	3.96	V	
Operation Temperature	$T_a$	-30	85	°C	5-1,2,3,4
Storage Temperature	$T_a$	-40	90	°C	5-1,2,3
LED Forward Current	IF	-	150	mA	Each LED

**Note 5:** The absolute maximum rating values of this product are not allowed to be exceeded at any times. Should a module be used with any of the absolute maximum ratings exceeded, the characteristics of the module may not be recovered, or in an extreme case, the module may be permanently destroyed.

**Note 5-1:**  $T_a$  = Ambient Temperature.

**Note 5-2:** This rating applies to all parts of the module and should not be exceeded.

**Note 5-3:** Maximum wet-bulb temperature is 58°C. Condensation of dew must be avoided as electrical current leaks will occur, causing a degradation of performance specification.

**Note 5-4:** The operating temperature only guarantees operation of the LCM and doesn't guarantee all the contents of Electro-optical specification.

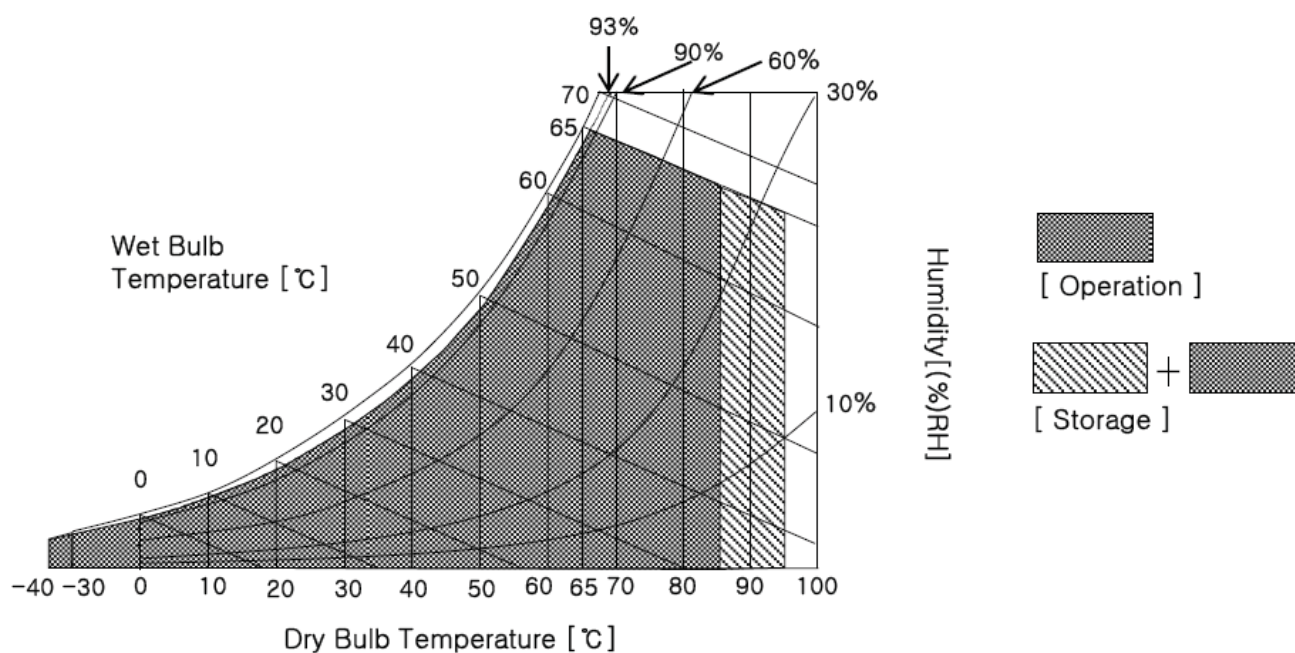



## 3.1.1. Typical Operation Conditions

(GND =0V)

Item	Symbol	Values			Unit	Remark
		Min.	Typ.	Max.		
Power voltage	$V_{DD}$	3.0	3.3	3.6	V	Note 6
Input logic high voltage	$V_{IH}$	$0.7 V_{DD}$	-	$V_{DD}$	V	Note 7
Input logic low voltage	$V_{IL}$	GND	-	$0.3 V_{DD}$	V	
Internal Pull low / high resistor	RI	200	350	850	k $\Omega$	Note 7

Note 6:  $V_{DD}$  setting should match the signals output voltage of customer's system board .

Note 7: RESET, STBYB, SELB(DINT), L/R, U/D

## 3.1.2. Current Consumption

(GND =0V)

Item	Symbol	Values			Unit	Remark
		Min.	Typ.	Max.		
Current for Driver	$I_{DD}$	255	315	375	mA	$V_{DD} = 3.3V$ @ full-white image

## 3.1.3. Backlight Driving Conditions

Item	Symbol	Values			Unit	Remark
		Min.	Typ.	Max.		
Voltage for LED backlight	$V_L$	19.6	21	23.8	V	Note 8
		21.6	23.2	26.3		Note 9
Current for LED backlight	$I_L$		244		mA	
LED life time	-	20,000			Hr	Note 10

Note 8: The LED Supply Voltage is defined by the number of LED at  $T_a=25^{\circ}\text{C}$  and  $I_L = 320\text{mA}$

Note 9: The LED Supply Voltage is defined by the number of LED at  $T_a= -40^{\circ}\text{C}$  and  $I_L = 320\text{mA}$

Note 10: The "LED life time" is defined as the module brightness decrease to 50% original brightness at  $T_a=25^{\circ}\text{C}$  and  $I_L = 320\text{mA}$ . The LED lifetime could be decreased if operating  $I_L$  is larger than 320mA.

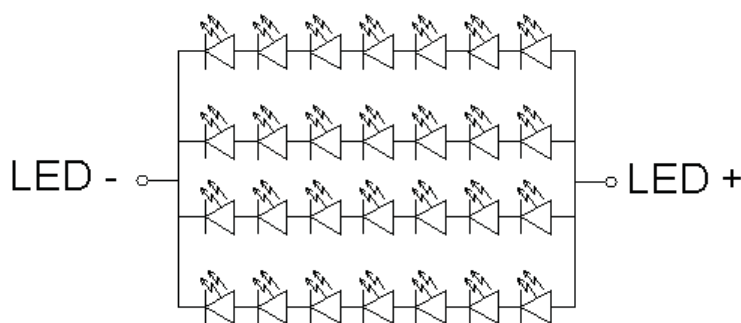

## 3.1.4 Backlight NTC Resistor

To limit the heat dissipation under high ambient temperature ( $T_a$ ). The LED string has a NTC (Negative Temperature Coefficient) to detect the ambient temperature of LED string. This NTC was located in the middle of FPC mounted with LED that acts as an indicator to show if the module is operated under safe operation region without overheating and damage. The detail application for this NTC, please refer to data sheet of Murata P/N : NCU15XH103F6SRC About Murata NCU15XH103F6SRC application. Please follow component data sheet.

### 3.1.5 De-rating diagram

LED power de-rating has to start at 70°C linear down to PWM 50% at 85°C before switching off, see graph as below.

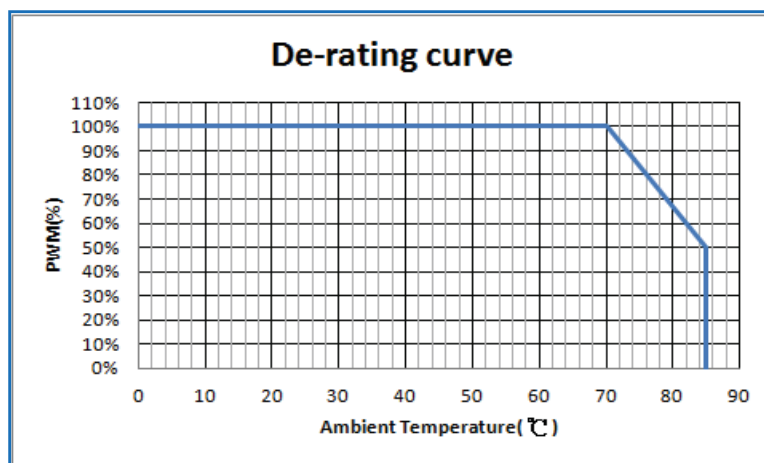

## 3.2. Power Sequence

VDD = 3.0~3.6V

a. Power on:

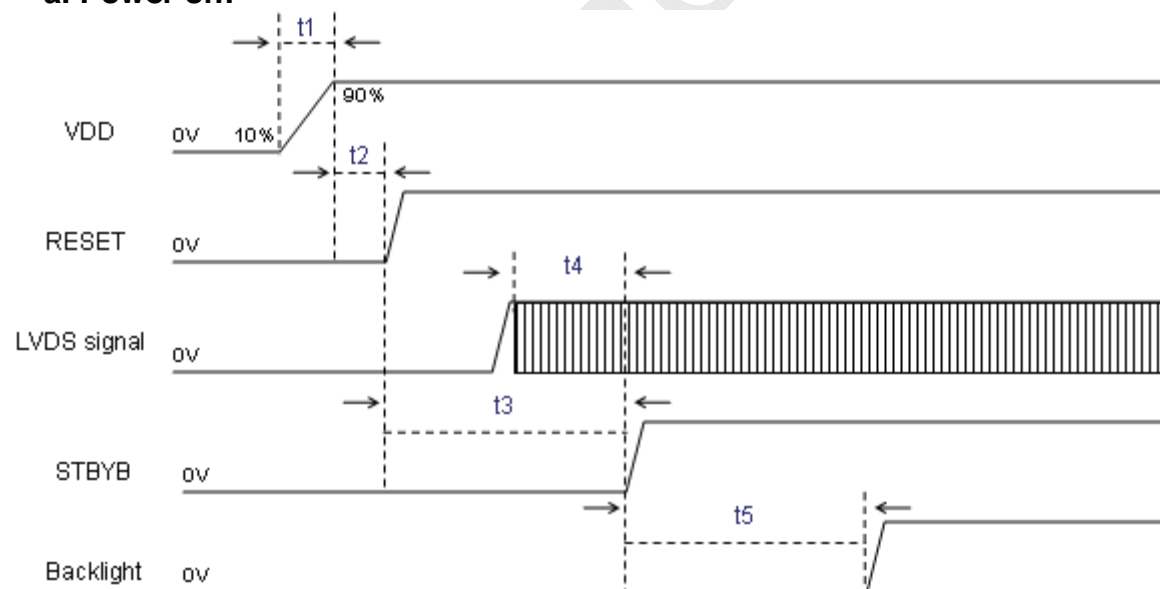

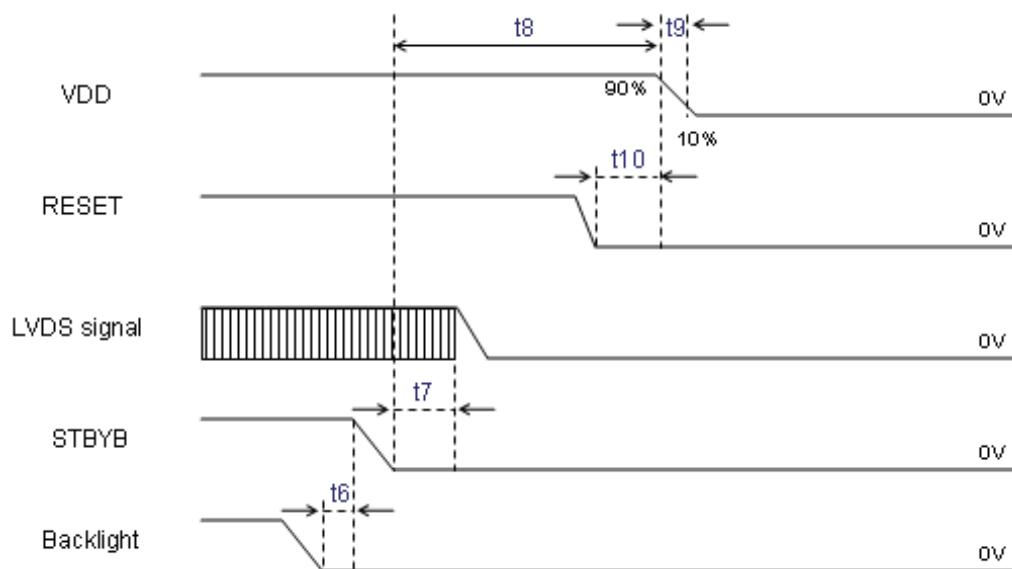
**b. Power off:**

Symbol	SPEC.			Unit
	Min.	Typ.	Max.	
t1	0.5	5	--	ms
t2	30	40	--	us
t3	10	15	--	ms
t4	1	5	t3	ms
t5	100	117	--	ms
t6	0	25	--	ms
t7	118	119	t8	ms
t8	120	128	--	ms
t9	0.5	5	--	ms
t10	0	5	t8	ms

### 3.3. Timing Characteristics

#### 3.3.1. AC Electrical Characteristics

Parameter	Symbol	Spec.			Unit	Remark
		Min.	Typ.	Max.		
Clock frequency	FLVCYC	10	-	85	MHz	Frame rate=60Hz
Clock Period	TLVCYC	11.76	-	100	Nsec	Frame rate=60Hz
1 data bit time	UI	-	1/7	-	TLVCYC	
Clock high time	LVHW	2.9	4	4.1	UI	Note 11
Clock low time	LVLW	2.9	3	4.1	UI	
Position 1	TPOS1	-0.2	0	0.2	UI	
Position 0	TPOS0	0.8	1	1.2	UI	
Position 6	TPOS6	1.8	2	2.2	UI	
Position 5	TPOS5	2.8	3	3.2	UI	
Position 4	TPOS4	3.8	4	4.2	UI	
Position 3	TPOS3	4.8	5	5.2	UI	
Position 2	TPOS2	5.8	6	6.2	UI	
Input eye width	TEYEW	0.6	-	-	UI	
Input eye border	TEX	-	-	0.2	UI	
LVDS wake up time	TENLVDS	-	-	150	ns	

Note 11: Please refer to “3.3.2 Input Clock and Data Timing Diagram”

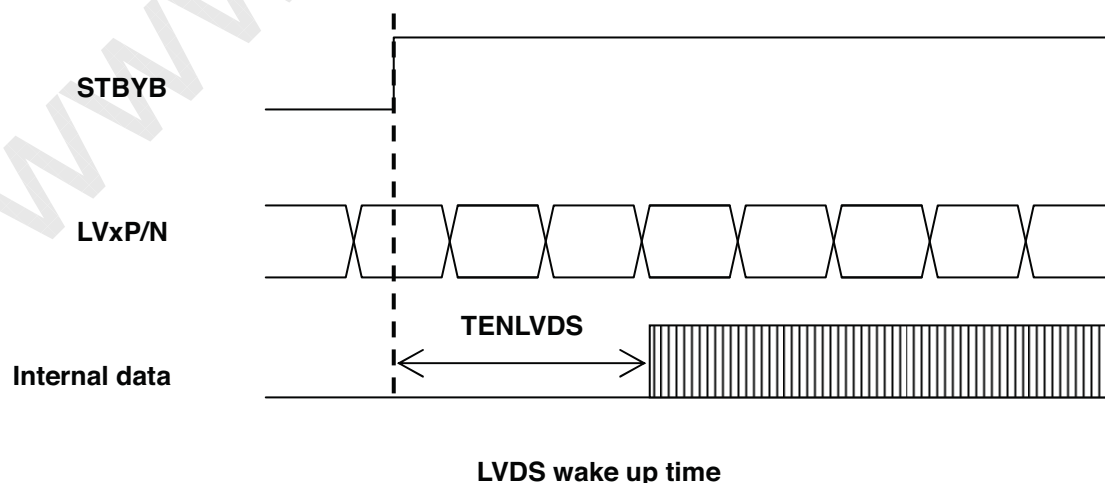



# PRODUCT SPECIFICATION

## 3.3.2. Input Clock and Data Timing Diagram

LVDS input timing:

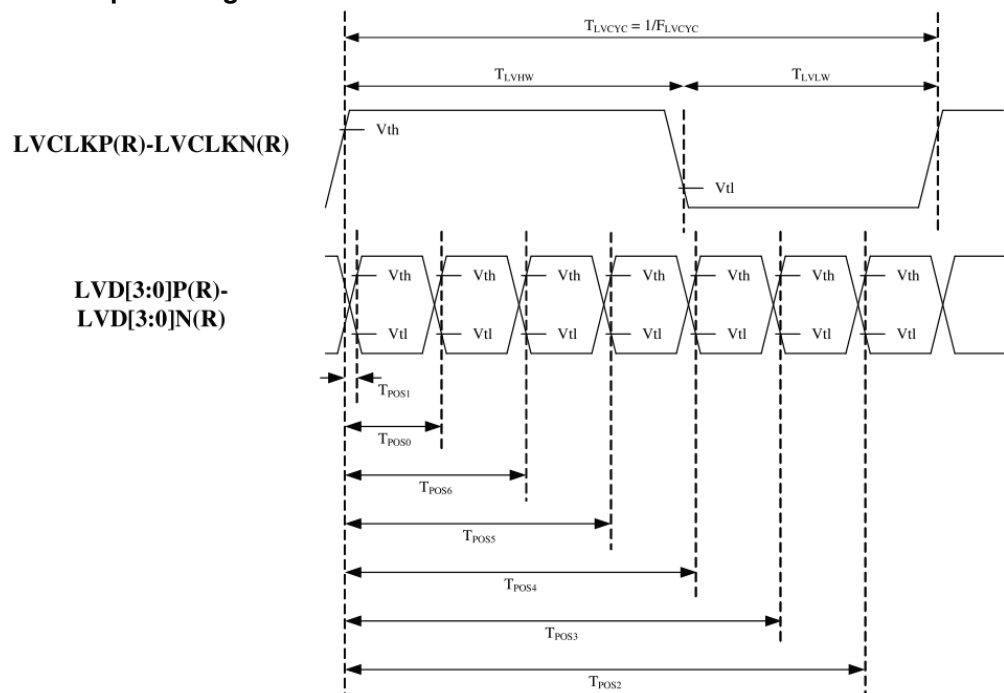

Differential:

LVD[3:0]P-LVD[3:0]N

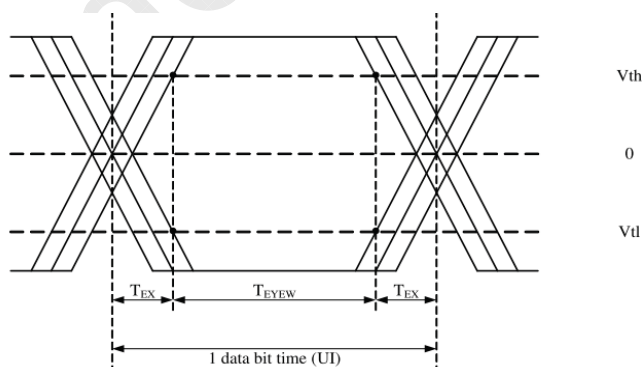

LVDS input eye diagram

**3.3.3. DC Electrical Characteristics**

Parameter	Symbol	Spec.			Unit	Remark
		Min.	Typ.	Max.		
Differential input high Threshold voltage	Vth	-	-	+0.1	V	Vcm=1.2V
Differential input low Threshold voltage	Vtl	-0.1	-	-	V	
Differential input common Mode voltage	Vcm	1	1.2	1.8-IV <sub>id</sub> /2	V	-
LVDS input voltage	V <sub>INLV</sub>	0.7		1.8	V	-
Differential input voltage	IV <sub>id</sub>	0.2	-	0.6	V	-
Differential input leakage Current	Vleak	-10	-	+10	μA	-
Termination Resistor	Z <sub>id</sub>	95	100	105	Ω	-

Differential:  
 LVCLKP(R)-LVCLKN(R),  
 LVD[3:0]P(R)-  
 LVD[3:0]N(R)

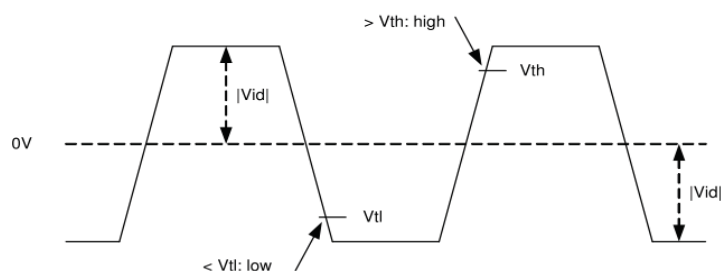



### 3.3.4. Timing

## PRODUCT SPECIFICATION

Parameter	Symbol	Values			Unit	Remark
		Min.	Typ.	Max.		
DCLK Frequency	F DCLK	58.5	63.7	76.3	MHz	Frame rate=60Hz
Horizontal valid data	t hd	1280			DCLK	
H-blanking	t hb	56	60	192	DCLK	
1 Horizontal Line	t h	1336	1340	1472	DCLK	
Vertical valid data	t vd	720			H	
V-blanking	t vb	10	72	144	H	
1 Vertical field	t v	730	792	864	H	

Note 12: DE mode only.

### 3.3.5. Data Input Format

LVDS, 6-bit:

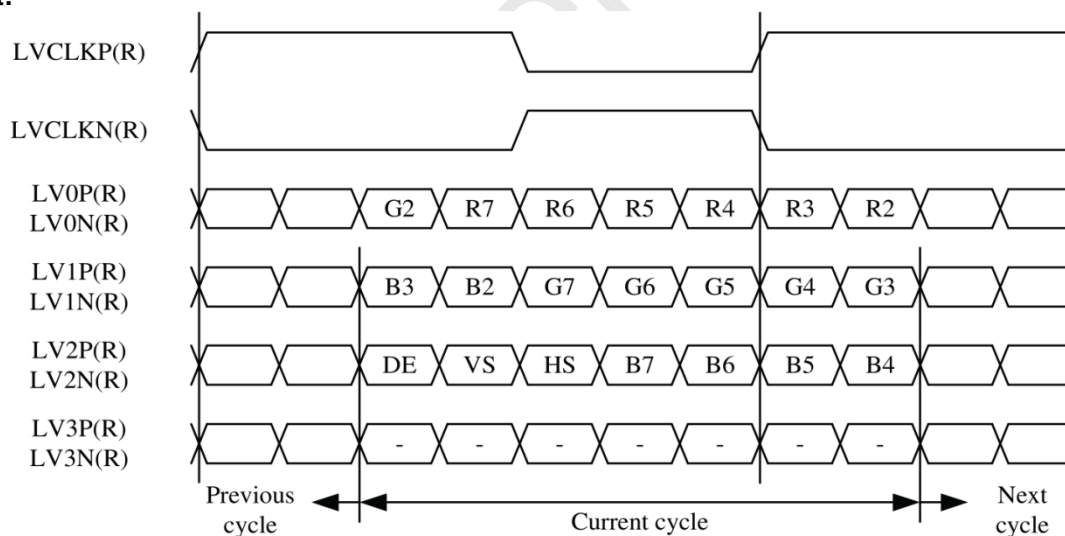

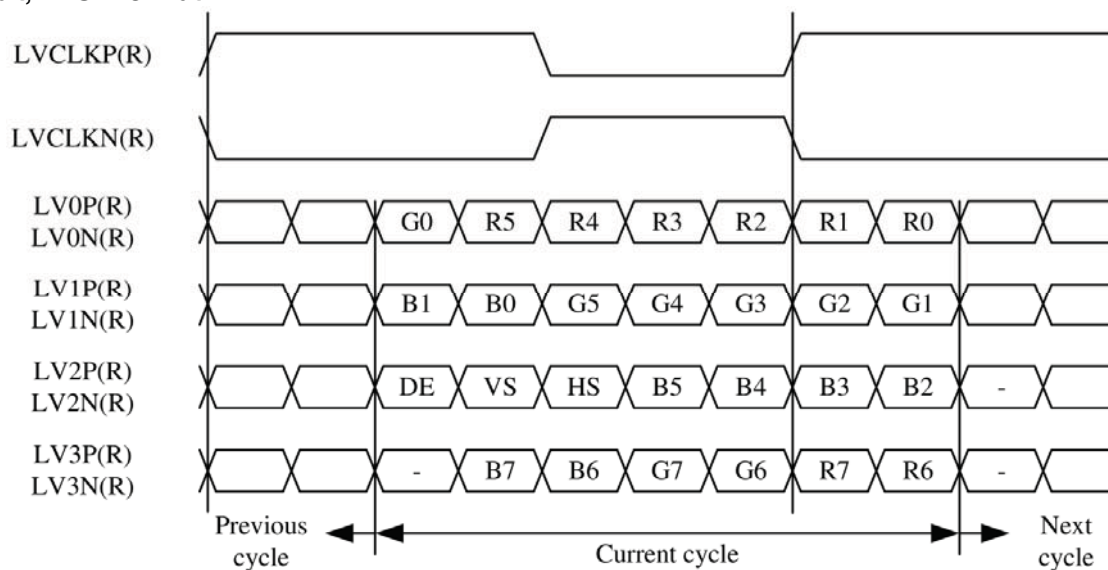

**LVDS, 8-bit, VESA format:**

### 3.3.6. Reset timing

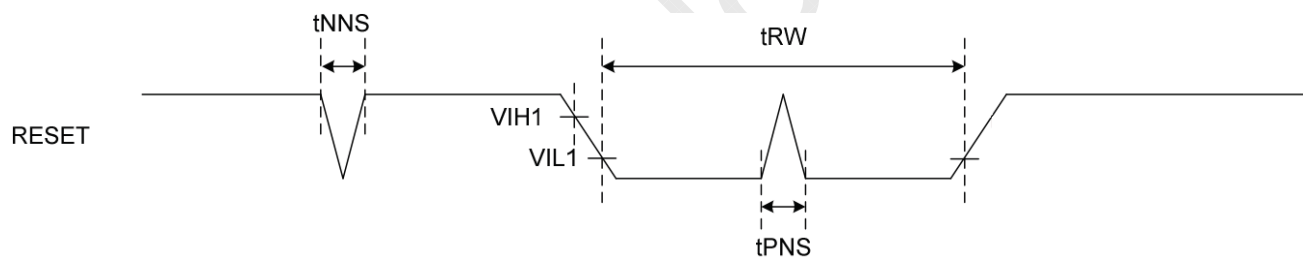
**(VDD=3.3V~3.6V)**

Signal	Parameter	Symbol	Spec.			Unit	Remark
			Min.	Typ.	Max.		
RESET	Reset pulse width	tRW	10	-	-	μs	-
	Positive spike noise width	tPNS	-	-	100	ns	-
	Negative spike noise width	tNNS	-	-	100	ns	-

## 4. Optical Specifications

Item	Symbol	Condition	Values			Unit	Remark
			Min.	Typ.	Max.		
Viewing angle (CR≥ 10)	$\theta_L$	$\Phi=180^\circ$ (9 o'clock)	80	85	-	degree	Note 1
	$\theta_R$	$\Phi=0^\circ$ (3 o'clock)	80	85	-		
	$\theta_T$	$\Phi=90^\circ$ (12 o'clock)	80	85	-		
	$\theta_B$	$\Phi=270^\circ$ (6 o'clock)	80	85	-		
Response time	$T_{ON}$	Normal $\theta=\Phi=0^\circ$	-	15	20	msec	Note 3
	$T_{OFF}$		-	10	15	msec	Note 3
Contrast ratio	CR		600	1000	-	-	Note 2 Note 4
Color chromaticity (CIE 1931)	$W_X$		0.26	0.31	0.36	-	Note 2 Note 5
	$W_Y$		0.28	0.33	0.38	-	
NTSC (CIE 1931)			65	70	-	%	Note 2 Note 5
Luminance	L		600	750	-	cd/m <sup>2</sup>	Note 5
Luminance uniformity	$Y_U$		75	80	-	%	Note 6 Note 7

### Test Conditions:

1.  $DV_{DD}=3.3V$ ,  $I_L=244mA$  (Backlight current), the ambient temperature is 25°C.
2. The test systems refer to Note 2.

Note 1: Definition of viewing angle. The view angle for  $\Theta=85^\circ$  is measured by BM-5A.

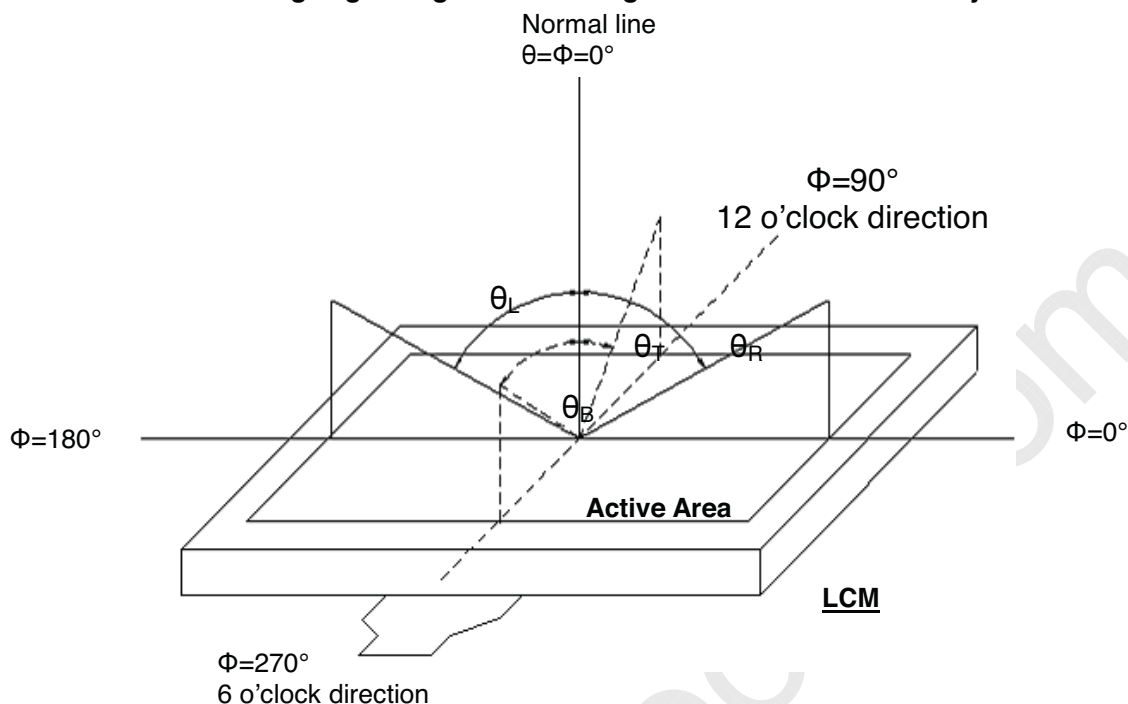

Fig. 4-1 Definition of viewing angle

Note 2: Definition of optical measurement system. The backlight has been light on for 30 minutes then measured the optical properties at the center point of the LCD screen in dark room. The color chromaticity, contrast ratio are measured by DMS 803.

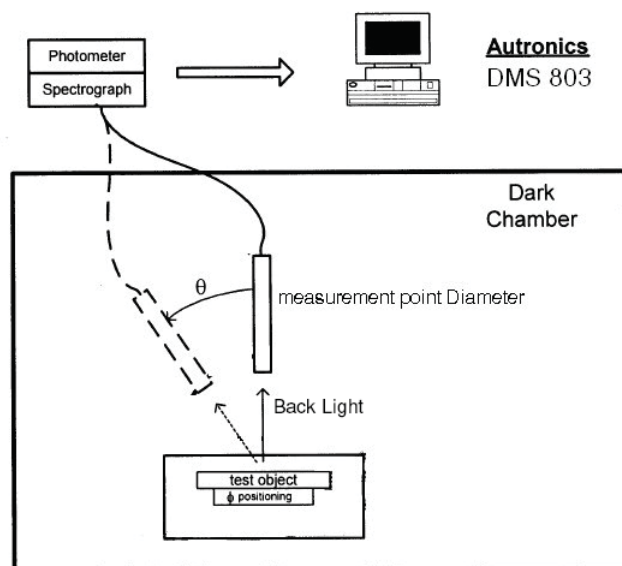
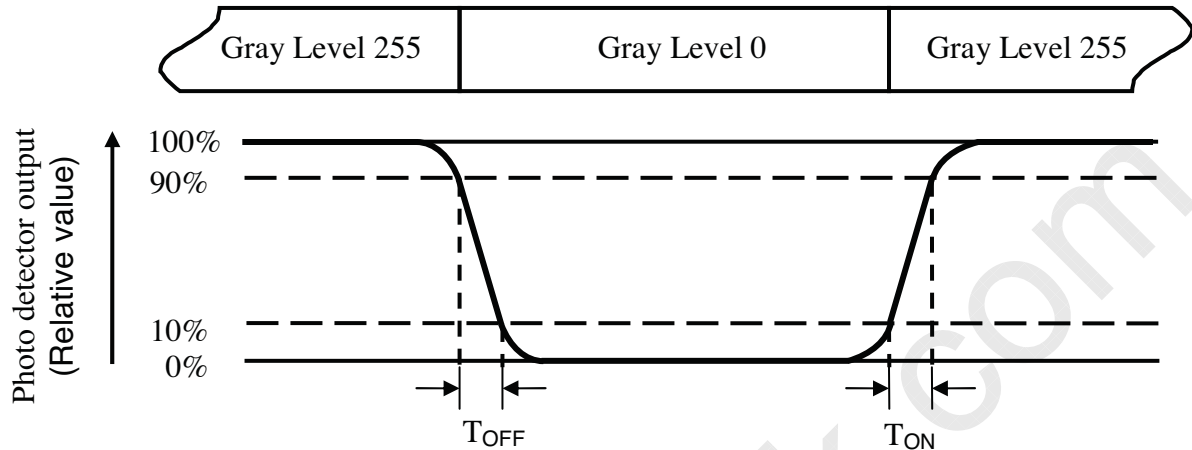

Fig. 4-2 Optical measurement system setup

**Note 3: Definition of response time.**The response time is measured by photo detector of oscilloscope.



**Fig. 4-3 Definition of response time**

**Note 4: Definition of contrast ratio**

$$\text{Contrast ratio (CR)} = \frac{\text{Luminance measured when LCD on the "White" state}}{\text{Luminance measured when LCD on the "Black" state}}$$

**Note 5: Color chromaticity is defined by CIE1931.**

Color coordinates measured at center point of LCD.

**Note 6: All input terminals LCD panel must be ground while measuring the center area of the panel. The LED driving condition is  $I_L = (244\text{mA})$ .**

**Note 7: Definition of luminance uniformity**

Active area is divided into 9 measuring areas (Refer to Fig. 4-4).

L----- Active area length    W----- Active area width

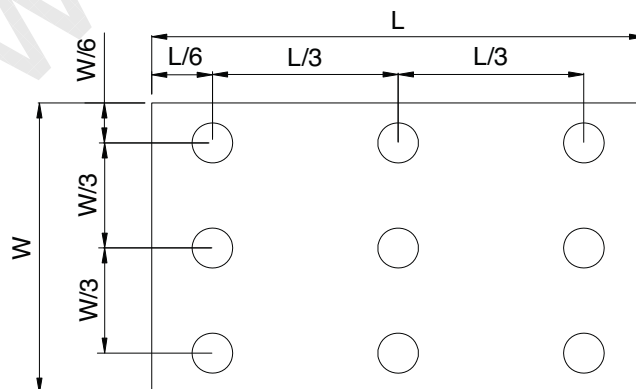

**Fig. 4-4 Definition of measuring points**

## 5. Reliability Test Items

Item	Test Conditions	Remark
High Temperature Storage Test	Ta=90°C, 500 hours	Note 1 Note 2 Note 3 Note 5
Low Temperature Storage Test	Ta=-40°C, 500 hours	
High Temperature Operation Test	Tp=85°C, 500 hours	
Low Temperature Operation Test	Tp=-30°C, 500 hours	
High Temperature & High Humidity Operation Test	Ta=60°C, RH 90%, 500hours	
Thermal Shock	[(Ta=-30°C 30min)→(Tp=85°C 30min)]/cycle · (Ramp rate ≥ 20°C/min) , 100cycles	
ESD Test (Non-Operation)	Condition 1 : C = 150pF, R = 330Ω Contact Discharge, ± 8KV Condition 2 : C = 150pF, R = 330Ω, Air Discharge, ± 15KV	Note 2
ESD Test (Operation)	Condition 1 : C = 150pF, R = 330Ω Contact Discharge, ± 8KV Condition 2 : C = 150pF, R = 330Ω, Air Discharge, ± 15KV	Note 6
Mechanical Shock	100G, 6ms, half sine wave, 3 times for each direction of ±X, ±Y, ±Z	Note 2 Note 4
Mechanical Vibration	Frequency: 10 ~55~10Hz;Sweep Mode: Log Sweep Sweep time: 1Oct/min; Acceleration: 1.5G;Test time:2 hr for each direction of X, Y, Z.	Note 2 Note 4
Packaging Vibration Test	1.47Grms X, Y, Z three axes (30min /axis) [Frequency : 5Hz(0.015G <sup>2</sup> /Hz) · 100Hz(0.015G <sup>2</sup> /Hz) · 200Hz(0.0037G <sup>2</sup> /Hz)]	
Packaging Drop Test	1corner, 3edges, 6faces (1 time/direction) <follow ISTA(1A) Height> 0kg ≤ W <10kg : 76cm, 10kg ≤ W <19kg : 61cm, 19kg ≤ W <28kg : 46cm, 28kg ≤ W <45kg : 31cm, 45kg ≤ W ≤ 68kg : 20cm	

Note 1:  $T_a$  = Ambient Temperature,  $T_p$  = Panel Surface Temperature.

Note 2: Criteria: Normal display image with no Function NG, or line defects.

Note 3: Evaluation should be tested after storage at room temperature for more than two hour

Note 4: At testing Vibration and Shock, the fixture in holding the module has to be hard and rigid enough so that the module would not be twisted or bent by the fixture.

Note 5: A certain level of Mura (non-uniformity) of dark / black image will happen several days after high temperature testing (H.T.T.). There is a slowly part recovery over a long time (several months). Such a long exposure time like in H.T.T. will normally not happen in a real application. Therefore the test H.T.T. was introduced to simulate cycles with normal conditions in-between but with the same total exposure time what show a significant reduced Mura.

The root cause is related to tension generated due to different amount of shrinking in the stack of layers in the polarizer sheet. The effect is more significant on larger displays like this size. An investigation into alternative polarizer material showed that there is no better alternative currently available.

Note 6: Criteria Class B: Some performance degradation allowed. No data loss. Self - recoverable No hardware failures

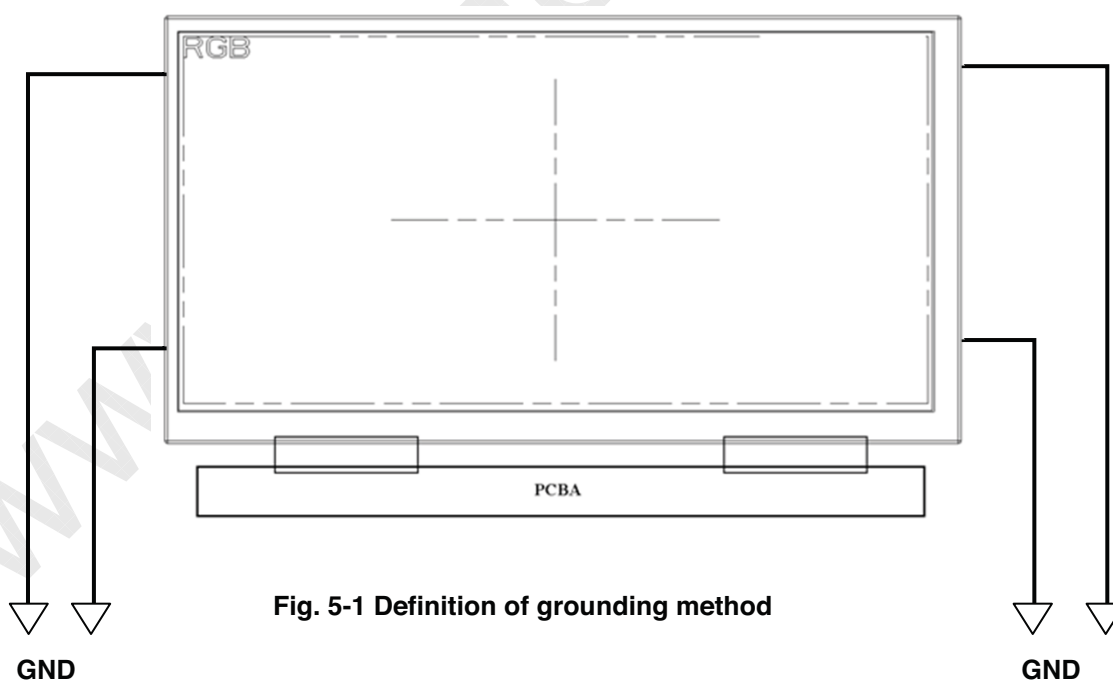

Fig. 5-1 Definition of grounding method

## 6. General Precautions

### 6.1. Safety

Liquid crystal is poisonous. Do not put it in your mouth. If liquid crystal touches your skin or cloths, wash it off immediately by using soap and water.

### 6.2. Handling

1. The LCD panel is plate glass. Do not subject the panel to mechanical shock or to excessive force on its surface.
2. The polarizer attached to the display is easily damaged. Please handle it carefully to avoid scratch or other damages.
3. To avoid contamination on the display surface, do not touch the module surface with bare hands.
4. Keep a space so that the LCD panels do not touch other components.
5. Put cover board such as acrylic board on the surface of LCD panel to protect panel from damages.
6. Transparent electrodes may be disconnected if you use the LCD panel under environmental conditions where the condensation of dew occurs.
7. Do not leave module in direct sunlight to avoid malfunction of the ICs.

### 6.3. Static Electricity

1. Be sure to ground module before turning on power or operating module.
2. Do not apply voltage which exceeds the absolute maximum rating value.

### 6.4. Storage

1. Store the module in a dark room where must keep at  $25\pm 10^{\circ}\text{C}$  and 65%RH or less.
2. Do not store the module in surroundings containing organic solvent or corrosive gas.
3. Store the module in an anti-electrostatic container or bag.

### 6.5. Cleaning

1. Do not wipe the polarizer with dry cloth. It might cause scratch.
2. Only use a soft sloth with IPA to wipe the polarizer, other chemicals might permanent damage to the polarizer.



# PRODUCT SPECIFICATION

## 7. Mechanical Drawing

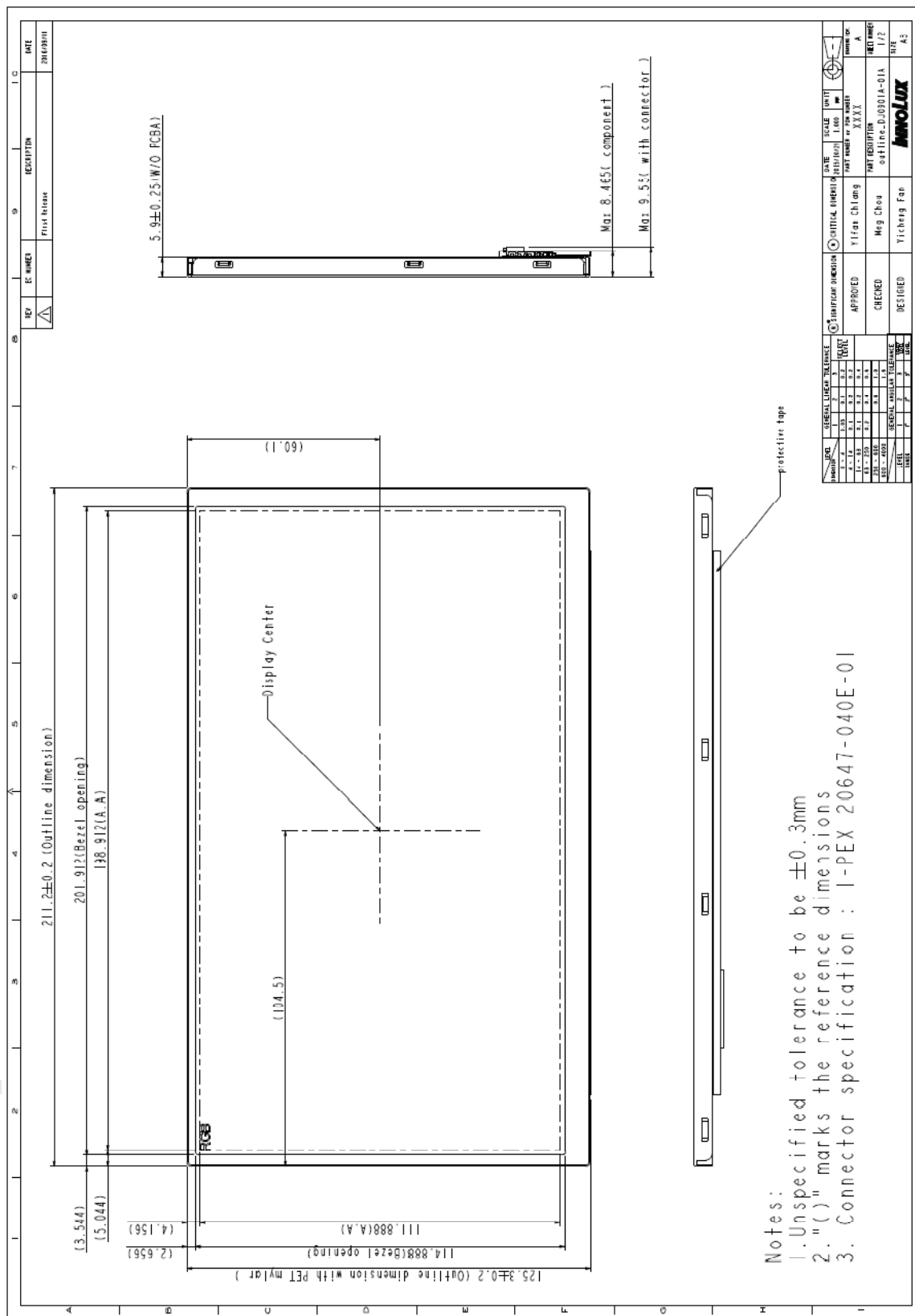







## PRODUCT SPECIFICATION

### 8. Package Drawing

#### 8.1. Packaging Material Table

No.	Item	Model (Material)	Dimensions(mm)	Unit Weight (kg)	Quantity	Remark
1	LCM Module	Model Name	211.2x125.3x5.9	0.23	21	
2	EPO Box	EPO	426x260x181	0.336	1	
3	protect film	PET	200.9x113.9	0.002	21	
3	A/S Bag	PE	230x168x0.04	0.005	21	
4	Carton	Corrugated paper	450x284x211	0.62	1	
5	Total weight	5.93kg				

#### 8.2. Packaging Quantity

Total LCM quantity in Carton : 21 pcs.



# PRODUCT SPECIFICATION

## 8.3. Packaging Drawing

Package

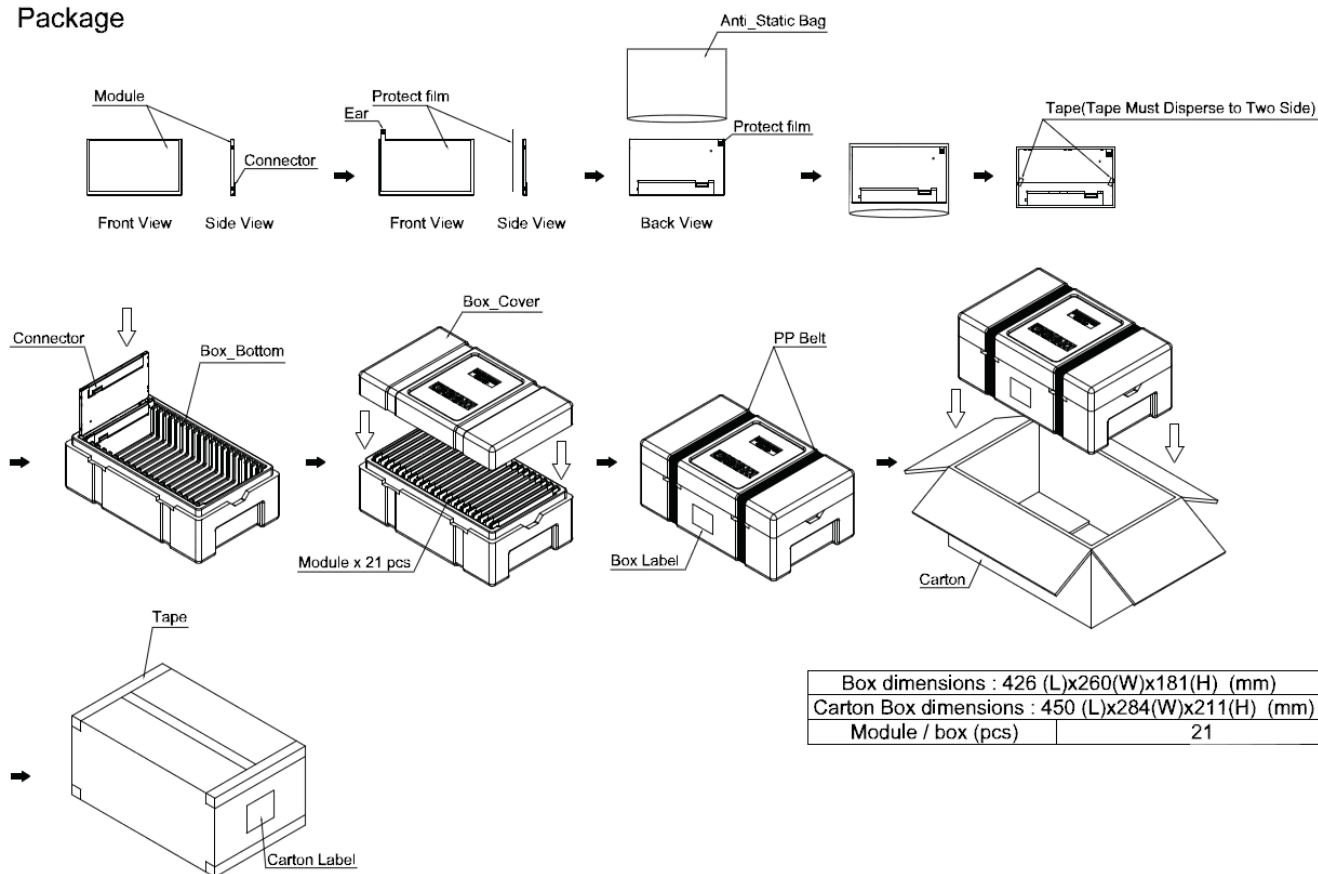

Box dimensions : 426 (L)x260(W)x181(H) (mm)	
Carton Box dimensions : 450 (L)x284(W)x211(H) (mm)	
Module / box (pcs)	21

www.pc



# PRODUCT SPECIFICATION

## 8.4. Shipping Drawing

### Shipping

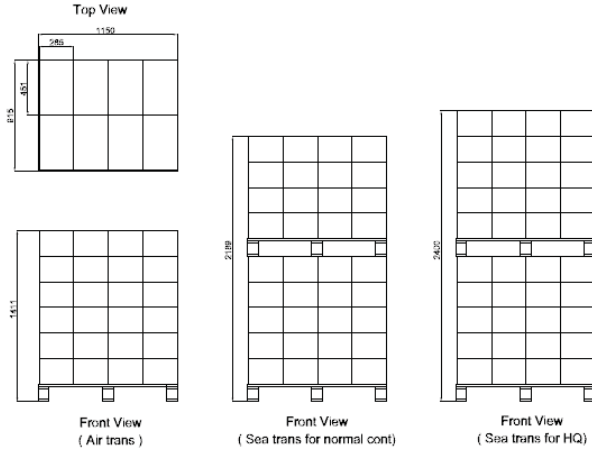

#### Pallet Type

Destination	Material	Pallet size(mm)
For customer	Wood	L1150xW915xH142
-	-	-

Trans type	Box / Top Pallet	Box / Bottom Pallet
Air	0	48
Sea	32	40
Sea for HQ	40	40

#### Storage Condition

Destination	Value	Unit
Temperature	0~35	°C
Humidity	40~80	%RH

Storage temperature and humidity conditions, reference the EDCC document : I130S-0045

