



SimpleLink™ Wi-Fi® Family

CC3100 / CC3200 Internet-on-a-chip™ Solutions



Save time and resources developing with CC3100 and CC3200 Wi-Fi® CERTIFIED™ chips and modules

Overview

TI makes connectivity even easier with the next-generation SimpleLink Wi-Fi solutions. The product family features Internet-on-a-chip™, Wi-Fi CERTIFIED™ solutions solving industry challenges for broad embedded applications. With SimpleLink CC3100 and CC3200 pin-to-pin-compatible solutions you can:

- Program applications on the industry's first Internet-on-a-chip solution with user-dedicated MCU
- Power Wi-Fi battery-operated designs for more than a year on two AA batteries
- Start quickly, no Wi-Fi experience needed

CC3100 Wireless Network Processor

The **CC3100 device** is a Wi-Fi, self-contained network processor with on-chip web server and embedded TCP/IP stack that connects

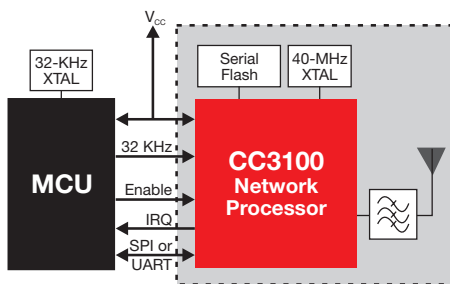

easily to any low-cost and low-power micro-controller (MCU) such as the MSP430F5529 or MSP430FR5969, due to a simple UART or SPI driver and host memory footprint as low as 7kB of code to reside on the MCU. Hardware design flexibility includes a 64-pin 9x9 mm QFN package or upcoming certified CC3100 module. Flexible connection methods (provisioning)

include Access Point Mode, WPS, SmartConfig™ Technology and others. On the security side, an embedded hardware cryptography engine allows establishing TLS secure Link in 200 ms.

Interfacing to any MCU, designed with low-power radio and advanced low-power modes, the SimpleLink Wi-Fi family makes sensor-to-the-cloud connectivity possible. Moreover, the solution contains several Internet protocols in ROM including mDNS, DNS, SSL/TLS and HTTP server.

CC3200 Wireless MCU

The **SimpleLink Wi-Fi CC3200 solution** capitalizes on the CC3100 benefits and integrates an 80-MHz ARM® Cortex®-M4 MCU and peripherals enabling application development with a Wi-Fi CERTIFIED device or module. Developers can fully access the MCU portion with more than 200kB of application code fully independent from the Wi-Fi processing. The peripheral set includes parallel camera,

I²S audio, SDMMC, ADC, SPI, UART, I²C, PWM, I/Os, built-in power management and RTC enabling connection to the cloud.

CC3200 certified modules, coming soon, provide easier Wi-Fi integration by lowering manufacturing costs, reducing development time and simplifying procurement and certification. The modules have complete antenna reference designs for streamlined integration.

Software and Support



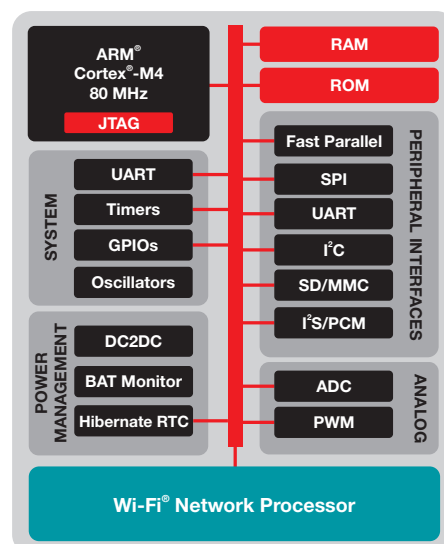

Both CC3100 and CC3200 solutions are supported by a software development kit (SDK) including software drivers, sample applications, API guide, user documentation and a world-class support E2E™ community. On the integrated Cortex-M4, all sample applications in the SDK are supported with Code Composer Studio™ Integrated Development Environment and no RTOS. A few of the applications support IAR, GCC, Free RTOS, TI-RTOS.

Example applications:

- Internet-on-a-chip sample applications
 - Email from SimpleLink Wi-Fi solution
 - Information Center – get time and weather from Internet
 - http server – host a web page on SimpleLink Wi-Fi solution
 - XMPP – Instant Message chat client
 - Serial interface
- Wi-Fi sample apps
 - Easy Wi-Fi configuration
 - Station, AP modes
 - TCP/UDP
 - Security – Enterprise/Personal, TLS/SSL
- MCU peripheral samples apps



Getting started: SimpleLink™ CC3100 and CC3200 hardware development kits

Kit name	Description	When to buy this?
SimpleLink Wi-Fi C3200 Internet-on-a-chip wireless microcontroller (MCU)		
 <p>CC3200-LAUNCHXL \$29.99 USD</p>	<ul style="list-style-type: none"> • CC3200 Launchpad • Single-chip Internet of Things solution with integrated MCU 	Want to use Wi-Fi® wireless MCU – single-chip Internet-on-a-chip™
SimpleLink Wi-Fi CC3100 Internet-on-a-chip wireless network processor		
 <p>CC3100BOOST-CC31XXEMUBOOST-EXP430F5529LP \$49.99 USD</p>	<ul style="list-style-type: none"> • CC3100 BoosterPack + Advanced emulation board + MSP430F5529 Launchpad 	Want to evaluate all CC3100 sample apps, using TI's ultra-low-power MSP430™ MCU family
 <p>CC3100BOOST-CC31XXEMUBOOST \$36.99 USD</p>	<ul style="list-style-type: none"> • CC3100 BoosterPack + flashing and advanced debug capability • Compatible LaunchPads (sold separately) 	Want to use CC3100 with any other MCU. Need one EMUBOOST board for flashing, using radio tool, using SimpleLink Studio (MCU development on PC) or advanced debug
 <p>CC3100BOOST \$19.99 USD</p>	<ul style="list-style-type: none"> • CC3100 BoosterPack 	If buying additional CC3100BOOST boards – assuming you already have CC31XXEMUBOOST for flashing, radio tool and possible advanced debug
 <p>CC3100BOOST-MSP-EXP430FR5969 \$34.00 USD</p>	<ul style="list-style-type: none"> • CC3100 BoosterPack + MSP430FR5969 LaunchPad 	Want to evaluate CC3100 with TI's low power FRAM device MSP430FR5969

Growing cloud of ecosystem partners

The **TI IoT cloud ecosystem** helps manufacturers using TI technology to easily and rapidly connect more to the IoT. Open to cloud service providers with a differentiated service offering and value-added services running on one of TI's IoT solutions, the TI cloud ecosystem provides options to meet individual manufacturer needs. www.ti.com/simplelinkwificloud



TI Design Library: Wi-Fi and IoT development with SimpleLink Wi-Fi reference designs

Jump start system design and speed time to market with our comprehensive Wi-Fi reference designs. Each design includes schematic or block diagram, BOM and design files. Created by experts with deep system and product knowledge, the designs span across TI's portfolio of analog, embedded processor and connectivity products.



- **SimpleLink Wi-Fi Antenna Selection** enables evaluation and development of end applications requiring antenna diversity
- **Smart Plug with Remote Disconnect and Wi-Fi Connectivity** quickly creates networked load control devices for industrial building and home automation applications
- **Wi-Fi Audio Streaming Application** enables the capture, streaming and playback of audio from a digital microphone or a stereo/mono audio jack to another Wi-Fi-enabled device
- **SimpleLink Wi-Fi Connectivity in a Smart Electric Meter** implements a three-phase energy meter with Wi-Fi connectivity

Important Notice: The products and services of Texas Instruments Incorporated and its subsidiaries described herein are sold subject to TI's standard terms and conditions of sale. Customers are advised to obtain the most current and complete information about TI products and services before placing orders. TI assumes no liability for applications assistance, customer's applications or product designs, software performance, or infringement of patents. The publication of information regarding any other company's products or services does not constitute TI's approval, warranty or endorsement thereof.

The platform bar, Code Composer Studio, E2E, Internet-on-a-chip, MSP430, SimpleLink and SmartConfig are trademarks of Texas Instruments. All other trademarks are the property of their respective owners.

IMPORTANT NOTICE

Texas Instruments Incorporated and its subsidiaries (TI) reserve the right to make corrections, enhancements, improvements and other changes to its semiconductor products and services per JESD46, latest issue, and to discontinue any product or service per JESD48, latest issue. Buyers should obtain the latest relevant information before placing orders and should verify that such information is current and complete. All semiconductor products (also referred to herein as "components") are sold subject to TI's terms and conditions of sale supplied at the time of order acknowledgment.

TI warrants performance of its components to the specifications applicable at the time of sale, in accordance with the warranty in TI's terms and conditions of sale of semiconductor products. Testing and other quality control techniques are used to the extent TI deems necessary to support this warranty. Except where mandated by applicable law, testing of all parameters of each component is not necessarily performed.

TI assumes no liability for applications assistance or the design of Buyers' products. Buyers are responsible for their products and applications using TI components. To minimize the risks associated with Buyers' products and applications, Buyers should provide adequate design and operating safeguards.

TI does not warrant or represent that any license, either express or implied, is granted under any patent right, copyright, mask work right, or other intellectual property right relating to any combination, machine, or process in which TI components or services are used. Information published by TI regarding third-party products or services does not constitute a license to use such products or services or a warranty or endorsement thereof. Use of such information may require a license from a third party under the patents or other intellectual property of the third party, or a license from TI under the patents or other intellectual property of TI.

Reproduction of significant portions of TI information in TI data books or data sheets is permissible only if reproduction is without alteration and is accompanied by all associated warranties, conditions, limitations, and notices. TI is not responsible or liable for such altered documentation. Information of third parties may be subject to additional restrictions.

Resale of TI components or services with statements different from or beyond the parameters stated by TI for that component or service voids all express and any implied warranties for the associated TI component or service and is an unfair and deceptive business practice. TI is not responsible or liable for any such statements.

Buyer acknowledges and agrees that it is solely responsible for compliance with all legal, regulatory and safety-related requirements concerning its products, and any use of TI components in its applications, notwithstanding any applications-related information or support that may be provided by TI. Buyer represents and agrees that it has all the necessary expertise to create and implement safeguards which anticipate dangerous consequences of failures, monitor failures and their consequences, lessen the likelihood of failures that might cause harm and take appropriate remedial actions. Buyer will fully indemnify TI and its representatives against any damages arising out of the use of any TI components in safety-critical applications.

In some cases, TI components may be promoted specifically to facilitate safety-related applications. With such components, TI's goal is to help enable customers to design and create their own end-product solutions that meet applicable functional safety standards and requirements. Nonetheless, such components are subject to these terms.

No TI components are authorized for use in FDA Class III (or similar life-critical medical equipment) unless authorized officers of the parties have executed a special agreement specifically governing such use.

Only those TI components which TI has specifically designated as military grade or "enhanced plastic" are designed and intended for use in military/aerospace applications or environments. Buyer acknowledges and agrees that any military or aerospace use of TI components which have **not** been so designated is solely at the Buyer's risk, and that Buyer is solely responsible for compliance with all legal and regulatory requirements in connection with such use.

TI has specifically designated certain components as meeting ISO/TS16949 requirements, mainly for automotive use. In any case of use of non-designated products, TI will not be responsible for any failure to meet ISO/TS16949.

Products

Audio	www.ti.com/audio
Amplifiers	amplifier.ti.com
Data Converters	dataconverter.ti.com
DLP® Products	www.dlp.com
DSP	dsp.ti.com
Clocks and Timers	www.ti.com/clocks
Interface	interface.ti.com
Logic	logic.ti.com
Power Mgmt	power.ti.com
Microcontrollers	microcontroller.ti.com
RFID	www.ti-rfid.com
OMAP Applications Processors	www.ti.com/omap
Wireless Connectivity	www.ti.com/wirelessconnectivity

Applications

Automotive and Transportation	www.ti.com/automotive
Communications and Telecom	www.ti.com/communications
Computers and Peripherals	www.ti.com/computers
Consumer Electronics	www.ti.com/consumer-apps
Energy and Lighting	www.ti.com/energy
Industrial	www.ti.com/industrial
Medical	www.ti.com/medical
Security	www.ti.com/security
Space, Avionics and Defense	www.ti.com/space-avionics-defense
Video and Imaging	www.ti.com/video

TI E2E Community

e2e.ti.com

Mouser Electronics

Authorized Distributor

Click to View Pricing, Inventory, Delivery & Lifecycle Information:

[Texas Instruments:](#)

[CC31XXEMUBOOST](#)