

WEBENCH® 设计报告

 Design : 4046162/46 LMZ14202TZ-ADJ/NOPB
 LMZ14202TZ-ADJ/NOPB 14.0V-22.0V to 3.3V @ 2.0A
 VinMax = 22.0V

IOUT = 2.0A

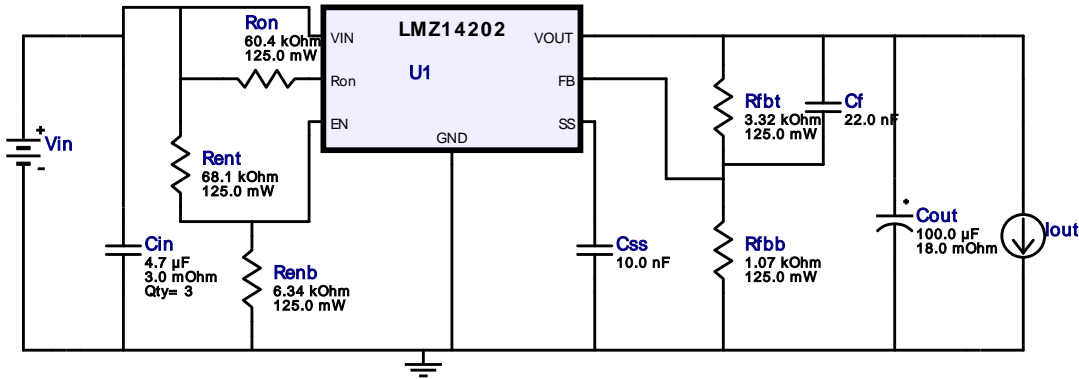

电气材料清单

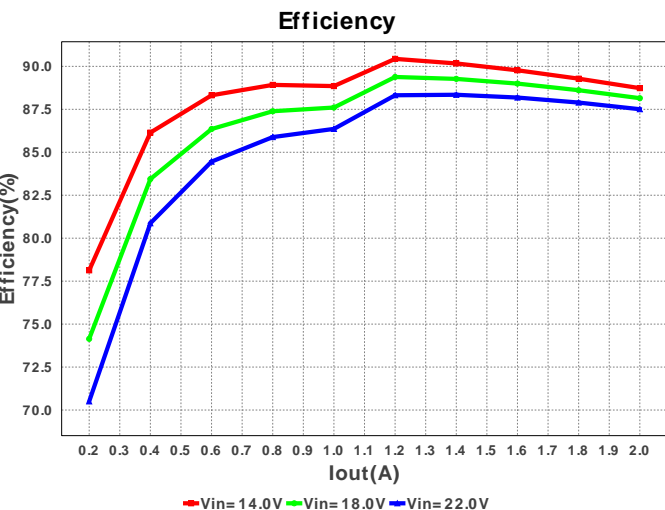
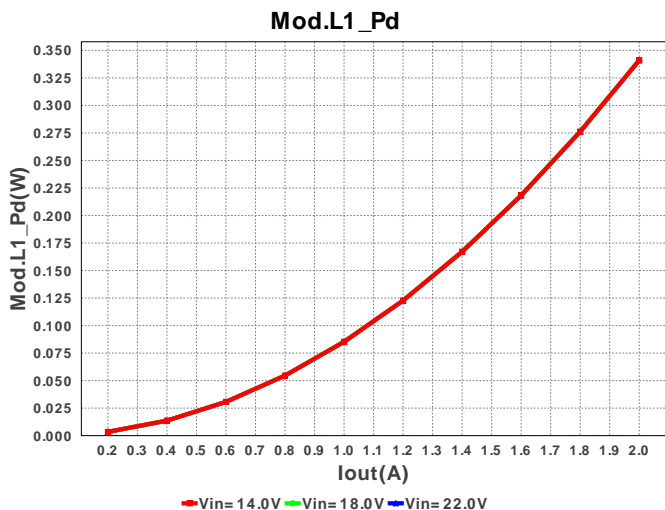
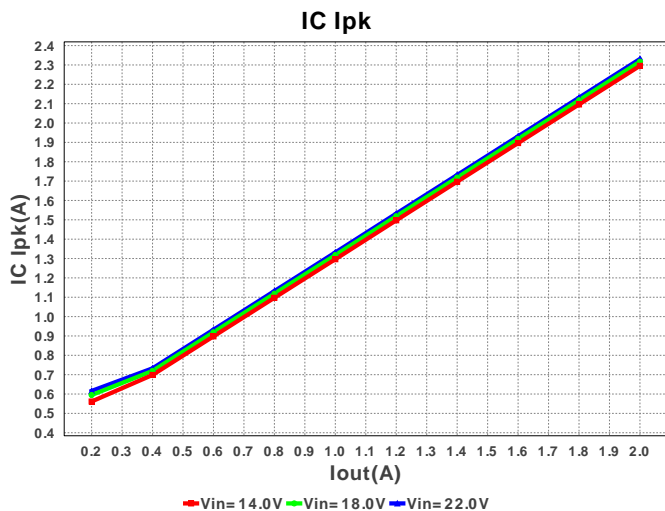
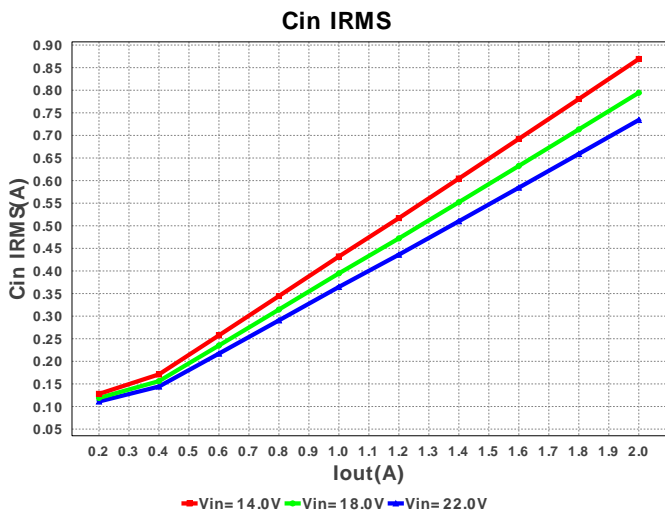
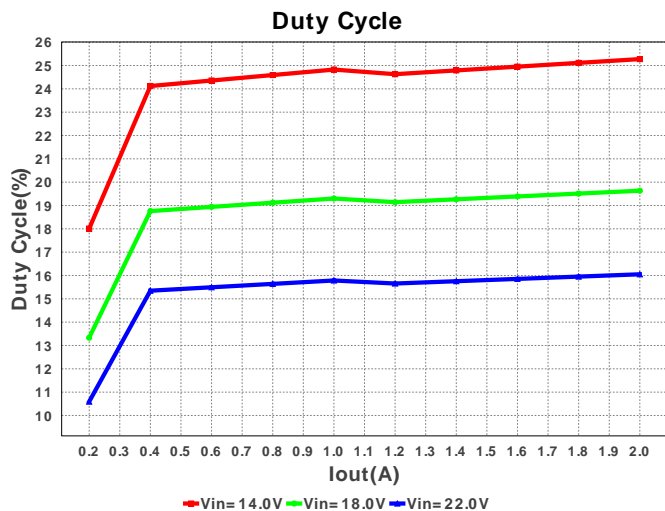
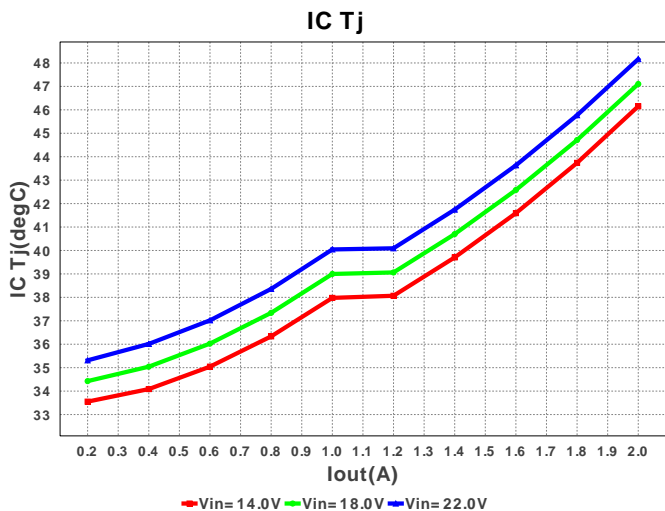
#	名称	制造商	零件编号	属性	Qty	Price	大小
1.	Cf	Yageo America	CC0805KRX7R9BB223 Series= X7R	Cap= 22.0 nF VDC= 50.0 V IRMS= 0.0 A	1	\$0.01	 0805 7mm2
2.	Cin	MuRata	GRM31CR71H475KA12L Series= X7R	Cap= 4.7 uF ESR= 3.0 mOhm VDC= 50.0 V IRMS= 4.98 A	3	\$0.10	 1206 11mm2
3.	Cout	Kemet	T520B107M006ATE018 Series= 249	Cap= 100.0 uF ESR= 18.0 mOhm VDC= 6.3 V IRMS= 2.7 A	1	\$0.56	 3528-21 17mm2
4.	Css	MuRata	GRM216R71H103KA01D Series= X7R	Cap= 10.0 nF VDC= 50.0 V IRMS= 0.0 A	1	\$0.01	 0805 7mm2
5.	Renb	Panasonic	ERJ-6ENF6341V Series= 225	Res= 6.34 kOhm Power= 125.0 mW Tolerance= 1.0%	1	\$0.01	 0805 7mm2
6.	Rent	Panasonic	ERJ-6ENF6812V Series= 225	Res= 68.1 kOhm Power= 125.0 mW Tolerance= 1.0%	1	\$0.01	 0805 7mm2
7.	Rfbb	Panasonic	ERJ-6ENF1071V Series= 225	Res= 1.07 kOhm Power= 125.0 mW Tolerance= 1.0%	1	\$0.01	 0805 7mm2
8.	Rfbb	Panasonic	ERJ-6ENF3321V Series= 225	Res= 3.32 kOhm Power= 125.0 mW Tolerance= 1.0%	1	\$0.01	 0805 7mm2
9.	Ron	Panasonic	ERJ-6ENF6042V Series= 225	Res= 60.4 kOhm Power= 125.0 mW Tolerance= 1.0%	1	\$0.01	 0805 7mm2
10.	U1	Texas Instruments	LMZ14202TZ-ADJ/NOPB	Switcher	1	\$7.76	 TZA07A 199mm2

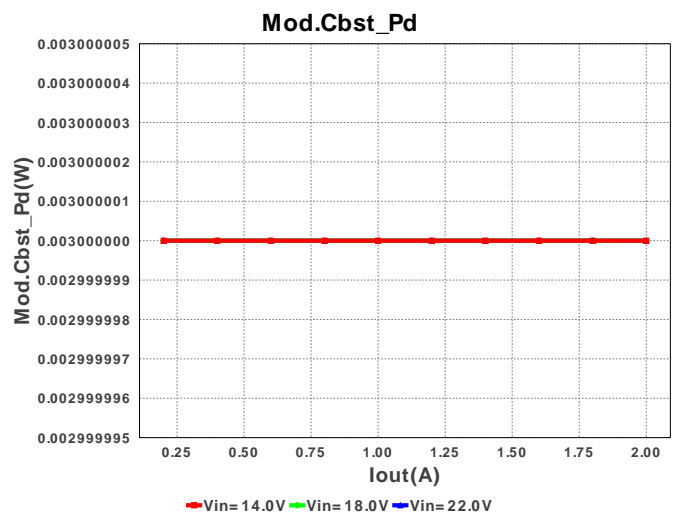
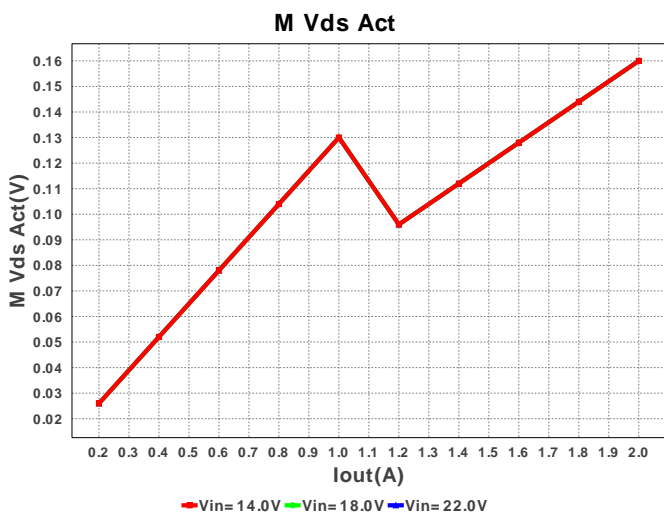
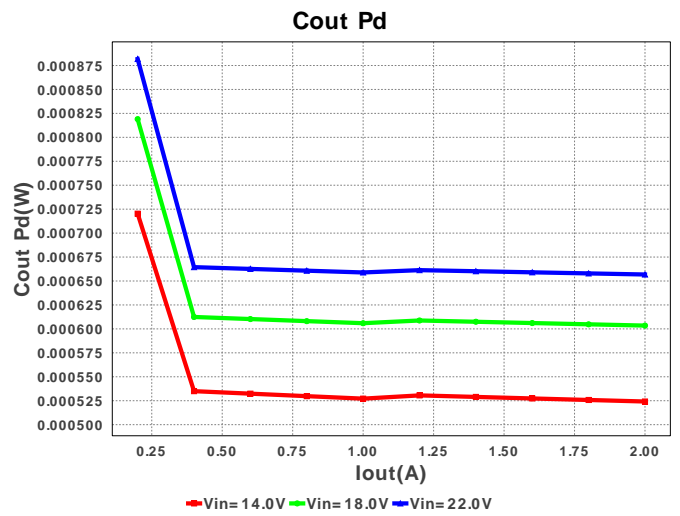
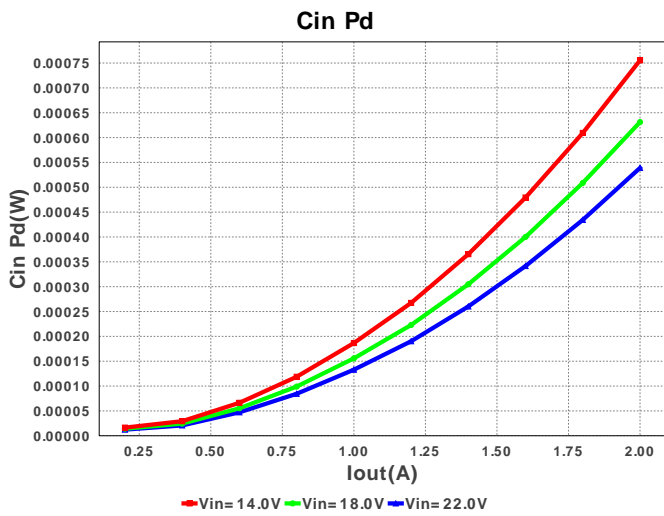
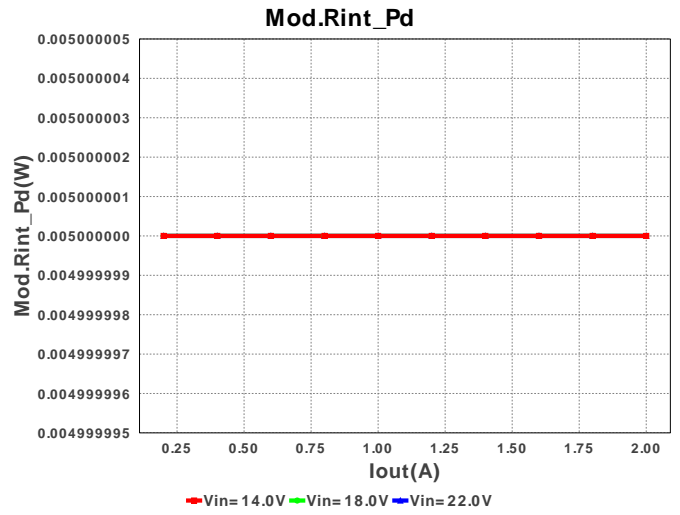
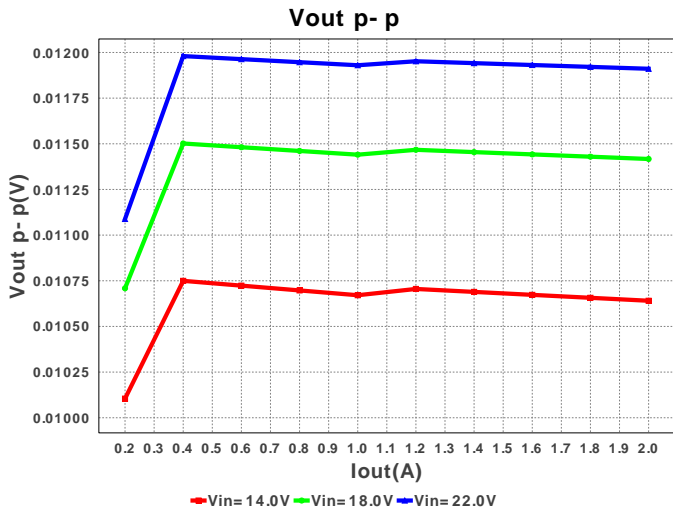

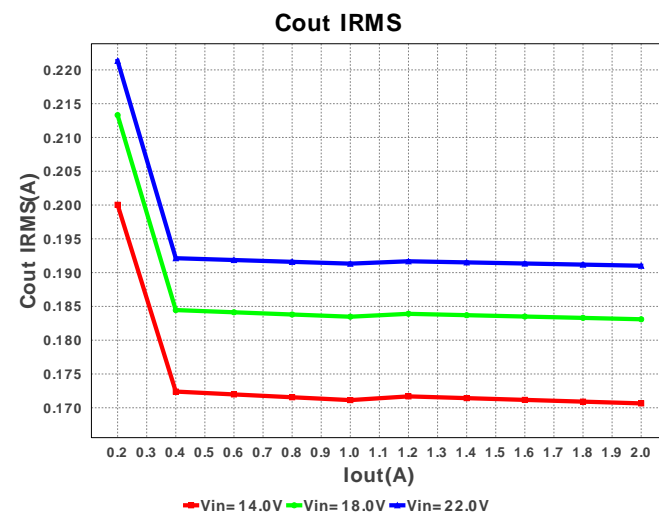
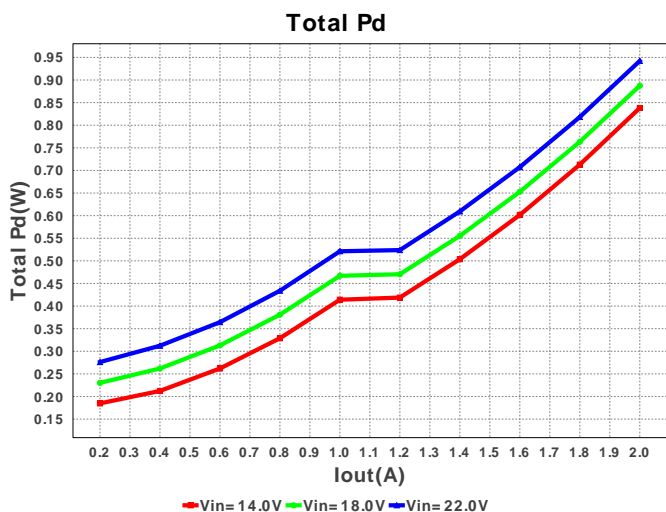
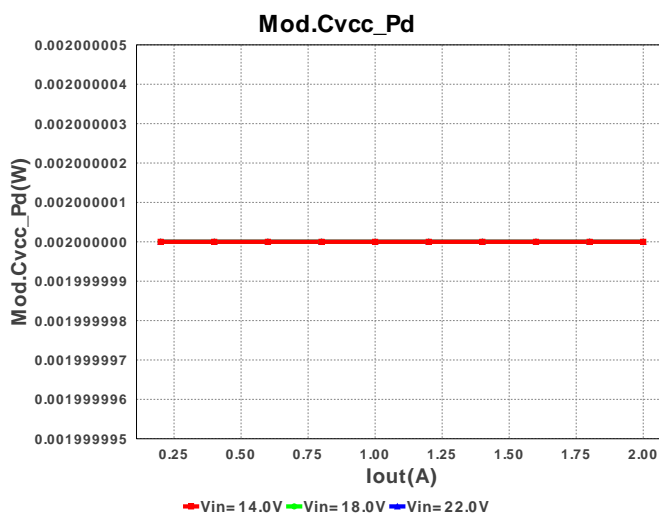
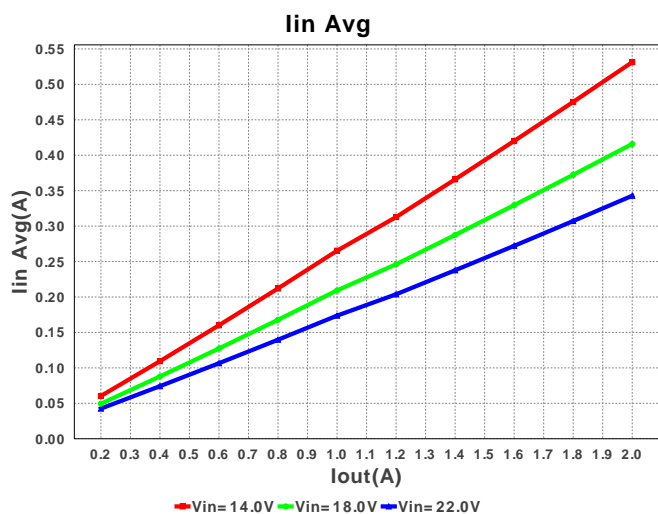
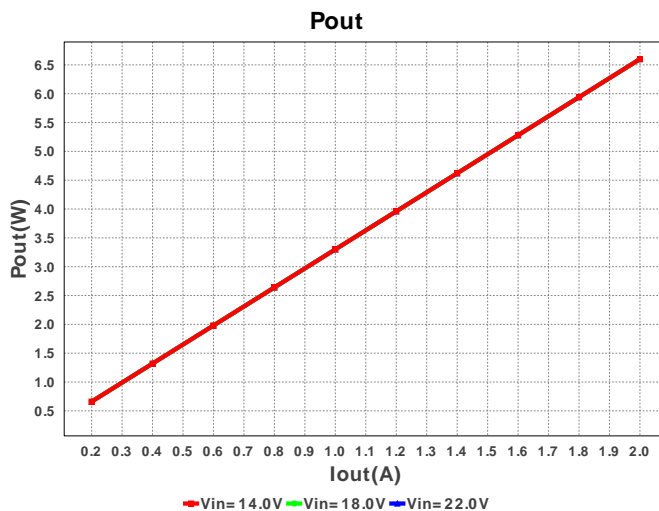
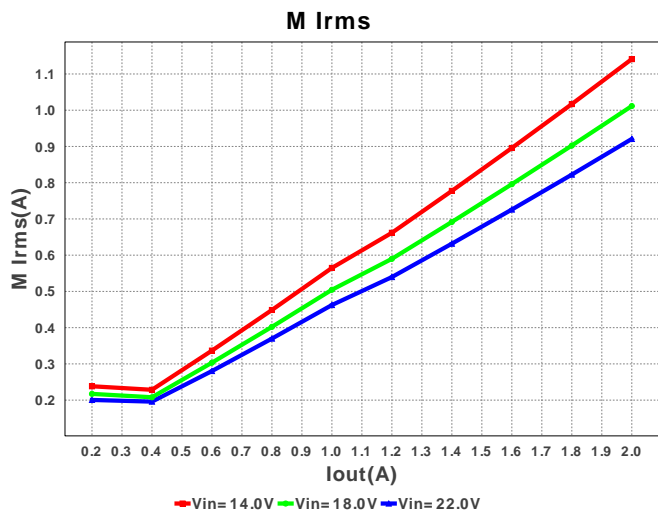

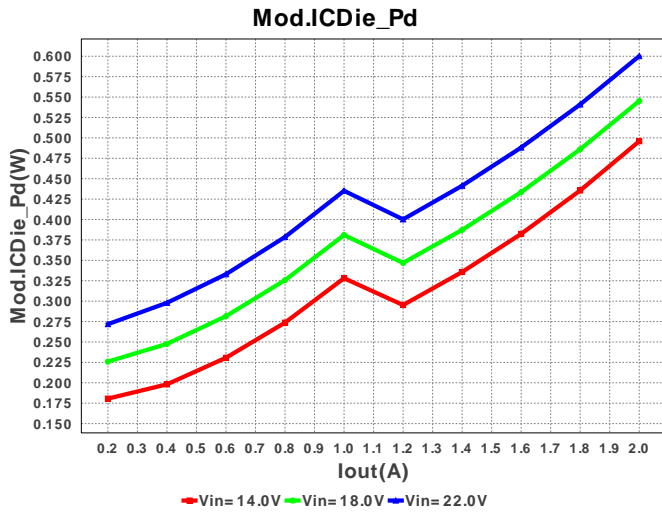



工作数值

#	名称	数值	类别	说明
1.	Cin IRMS	734.156 mA	Current	输入电容器均方根纹波电流
2.	Cout IRMS	191.019 mA	Current	输出电容器均方根纹波电流
3.	IC Ipk	2.331 A	Current	电路内的峰值开关电流
4.	Iin Avg	339.24 mA	Current	平均输入电流
5.	M1 Irms	911.639 mA	Current	Q lavg
6.	BOM 数量	12	General	Total Design BOM count
7.	大小	296.0 mm2	General	BOM组件的总所占面积
8.	频率	449.721 kHz	General	开关频率
9.	IC Tolerance	20.0 mV	General	IC Feedback Tolerance
10.	M Vds Act	160.0 mV	General	Voltage drop across the MosFET
11.	Pout	6.6 W	General	总输出功率
12.	总 BOM	\$8.68	General	Total BOM Cost
13.	Vout OP	3.3 V	Op_Point	Operational Output Voltage
14.	占空比	16.051 %	Op_point	占空比
15.	效率	88.432 %	Op_point	稳态效率
16.	IC Tj	46.639 degC	Op_point	电路接点温度
17.	ICThetaJA	19.3 degC/W	Op_point	电路接点到环境热敏电阻
18.	IOUT_OP	2.0 A	Op_point	Iout 操作点
19.	VIN_OP	22.0 V	Op_point	Vin操作点
20.	Vout p-p	11.911 mV	Op_point	峰值到峰值输出纹波电压
21.	Cin Pd	538.985 μW	Power	输入电容器功率耗散
22.	Cout Pd	656.789 μW	Power	输出电容器功率耗散
23.	整体 Pd	863.352 mW	Power	总功率耗散

设计输入

#	名称	数值	说明
1.	输出电流	2.0 A	最大输出电流
2.	Iout1	2.0 Amps	Output Current #1
3.	Vin 最大	22.0 V	最高输入电压
4.	Vin 最小	14.0 V	最低输入电压
5.	输出电压:	3.3 V	输出电压
6.	Vout1	3.3 Volt	Output Voltage #1
7.	base_pn	LMZ14202	美国国家半导体的产品编号
8.	源	DC	输入源类别
9.	工作环境温度	30.0 degC	环境温度

设计协助

1. LMZ14202 Product Folder : <http://www.ti.com/product/lmz14202> : contains the data sheet and other resources.

Texas Instruments' WEBENCH simulation tools attempt to recreate the performance of a substantially equivalent physical implementation of the design. Simulations are created using Texas Instruments' published specifications as well as the published specifications of other device manufacturers. While Texas Instruments does update this information periodically, this information may not be current at the time the simulation is built. Texas Instruments does not warrant the accuracy or completeness of the specifications or any information contained therein. Texas Instruments does not warrant that any designs or recommended parts will meet the specifications you entered, will be suitable for your application or fit for any particular purpose, or will operate as shown in the simulation in a physical implementation. Texas Instruments does not warrant that the designs are production worthy.

You should completely validate and test your design implementation to confirm the system functionality for your application prior to production.

Use of Texas Instruments' WEBENCH simulation tools is subject to [Texas Instruments' Site Terms and Conditions of Use](#). Prototype boards based on WEBENCH created designs are provided AS IS without warranty of any kind for evaluation and testing purposes and are subject to the terms of the [Evaluation License Agreement](#).