

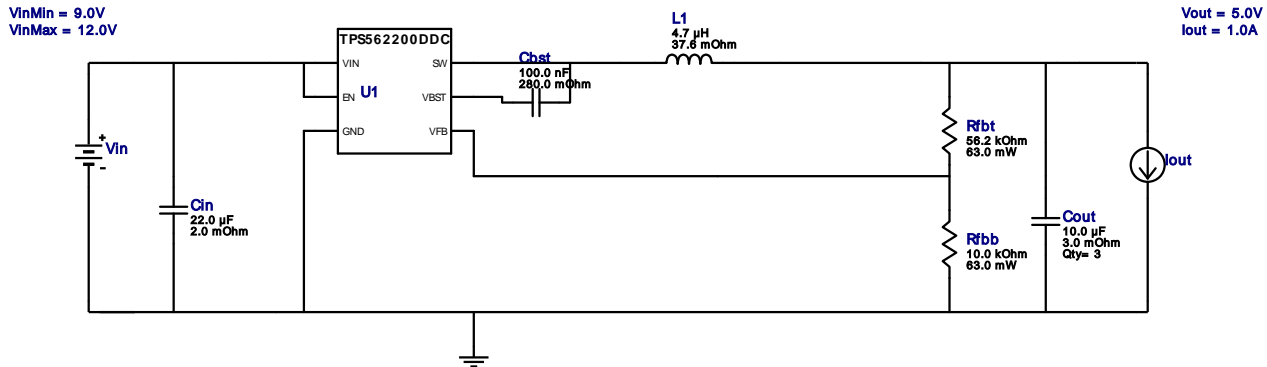







**WEBENCH<sup>®</sup> Design Report**

 Design : 1542746/396 TPS562200DDCR  
 TPS562200DDCR 9.0V-12.0V to 5.00V @ 1.0A

**Electrical BOM**

#	Name	Manufacturer	Part Number	Properties	Qty	Price	Footprint
1.	Cbst	AVX	08053C104KAT2A Series= X7R	Cap= 100.0 nF ESR= 280.0 mOhm VDC= 25.0 V IRMS= 0.0 A	1	\$0.01	 0805 7 mm <sup>2</sup>
2.	Cin	MuRata	GRM32ER61E226KE15L Series= X5R	Cap= 22.0 uF ESR= 2.0 mOhm VDC= 25.0 V IRMS= 3.67 A	1	\$0.28	 1210 15 mm <sup>2</sup>
3.	Cout	Kemet	C0805C106K8PACTU Series= X5R	Cap= 10.0 uF ESR= 3.0 mOhm VDC= 10.0 V IRMS= 11.43 A	3	\$0.04	 0805 7 mm <sup>2</sup>
4.	L1	Bourns	SRN6045-4R7Y	L= 4.7 uH DCR= 37.6 mOhm	1	\$0.16	 SRN6045 64 mm <sup>2</sup>
5.	Rfbb	Vishay-Dale	CRCW040210K0FKED Series= CRCW..e3	Res= 10.0 kOhm Power= 63.0 mW Tolerance= 1.0%	1	\$0.01	 0402 3 mm <sup>2</sup>
6.	Rfbt	Vishay-Dale	CRCW040256K2FKED Series= CRCW..e3	Res= 56.2 kOhm Power= 63.0 mW Tolerance= 1.0%	1	\$0.01	 0402 3 mm <sup>2</sup>
7.	U1	Texas Instruments	TPS562200DDCR	Switcher	1	\$0.69	 DDC0006A 10 mm <sup>2</sup>

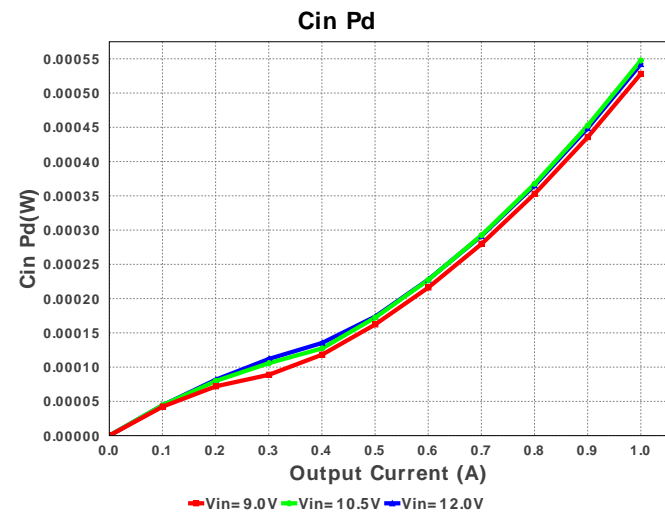
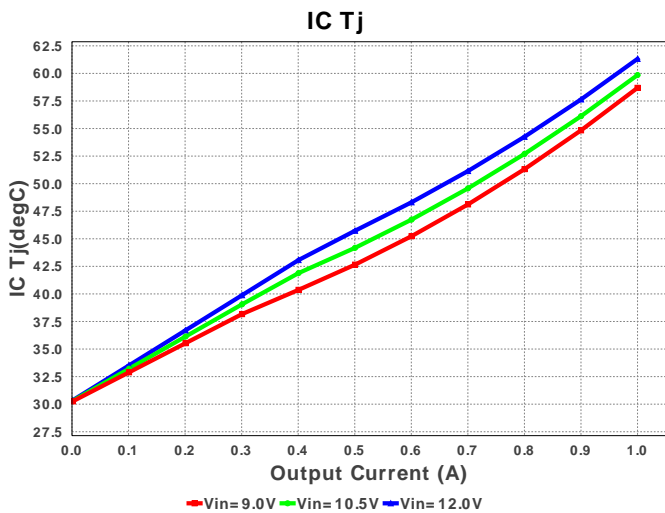
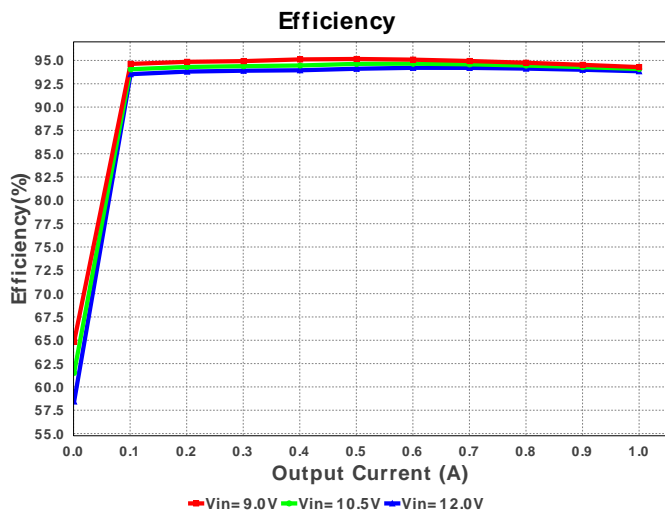
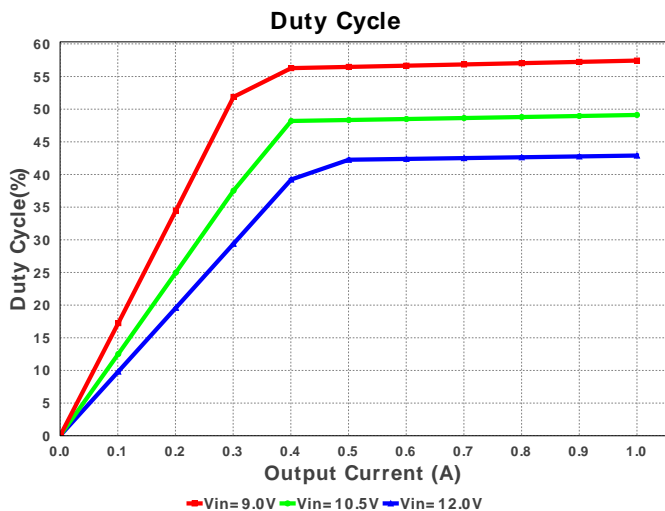
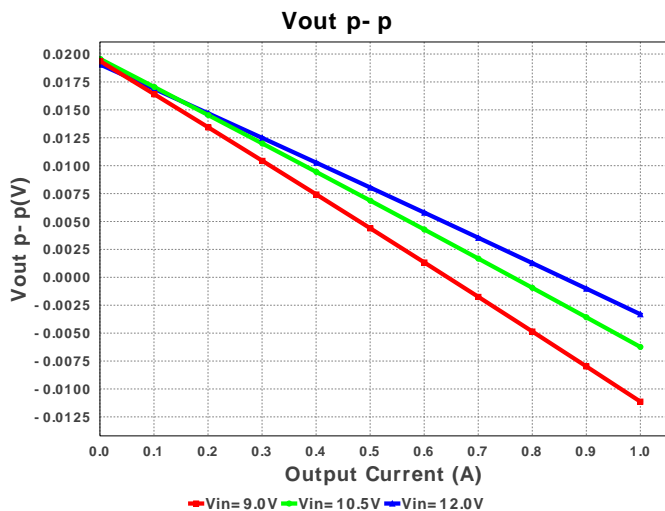
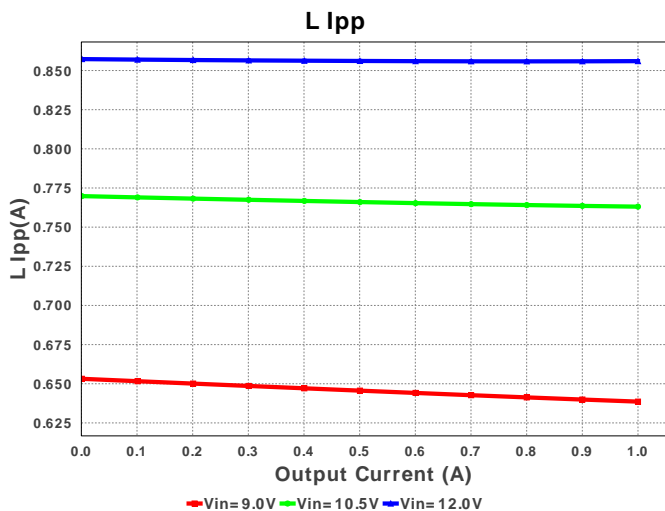
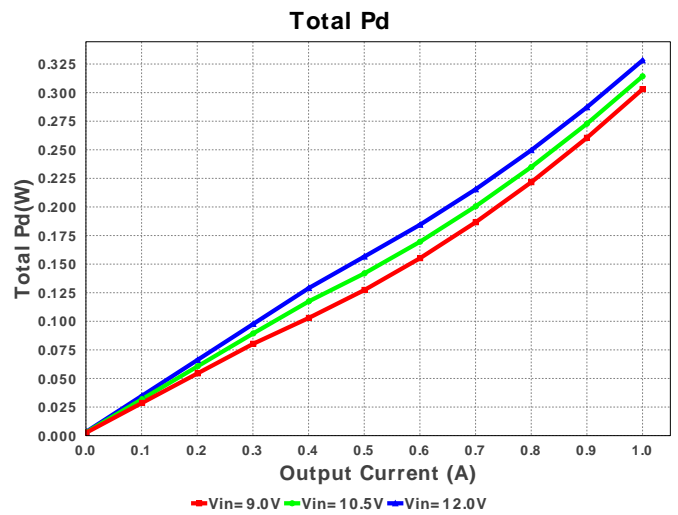
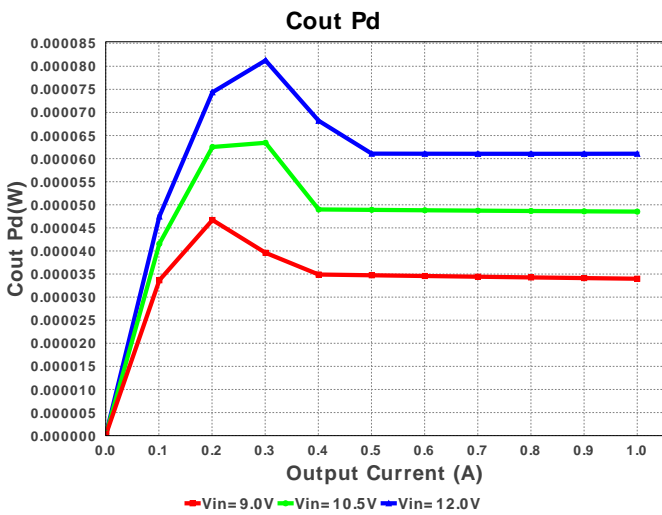
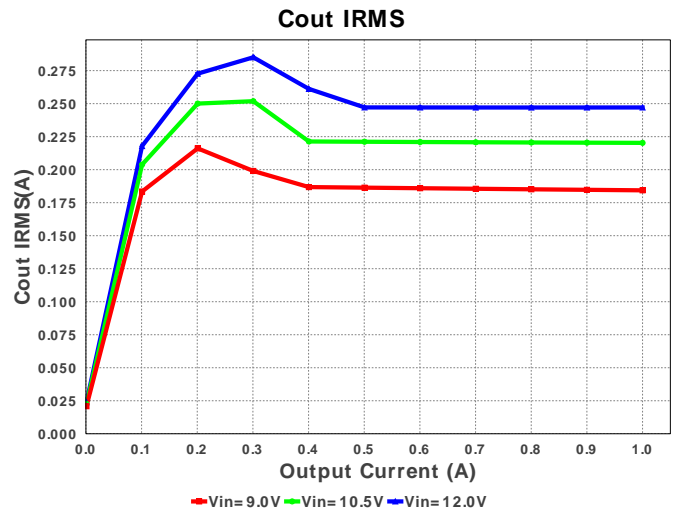
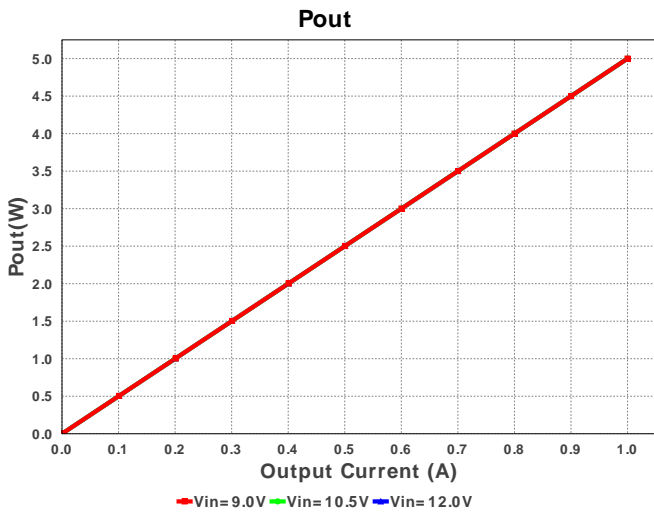
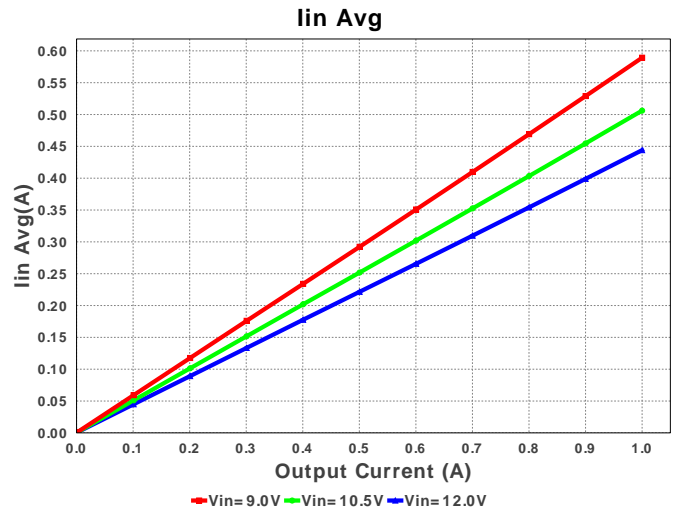
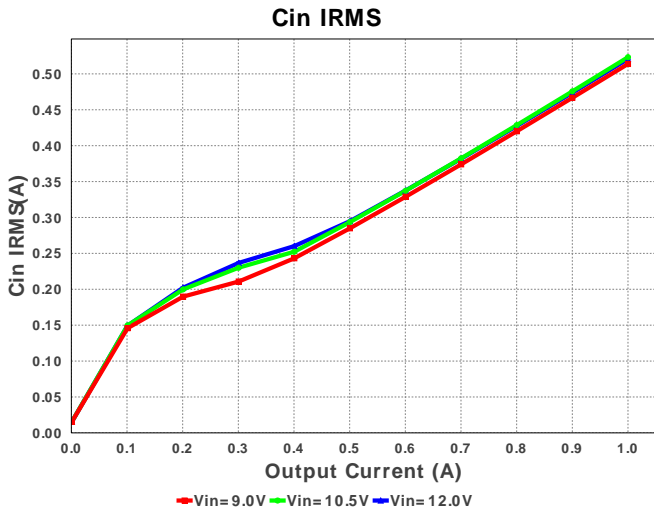

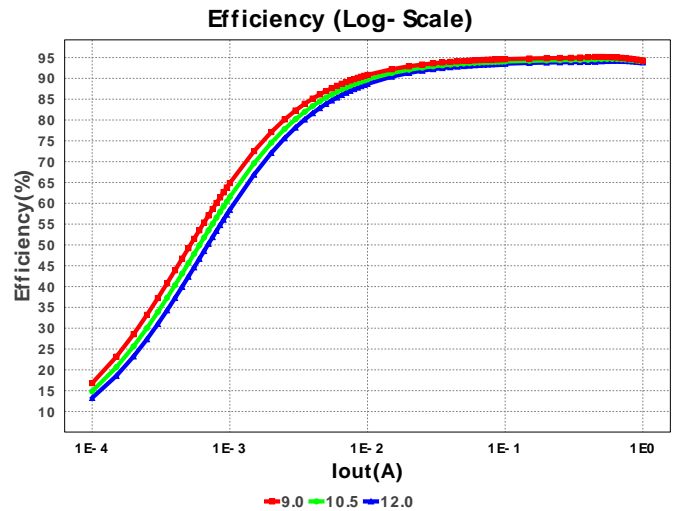
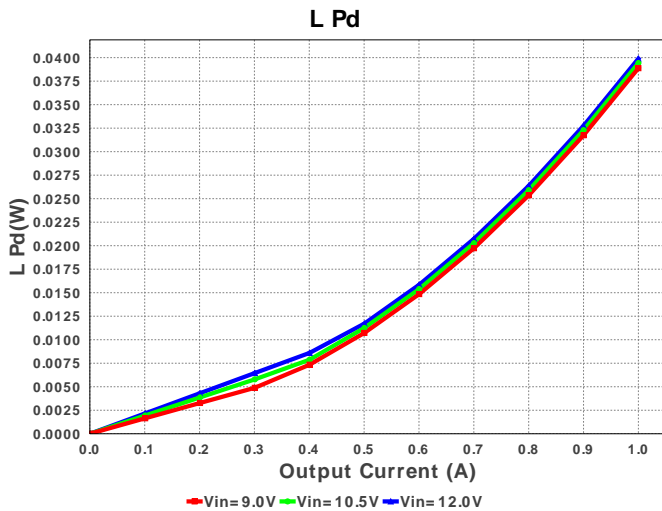
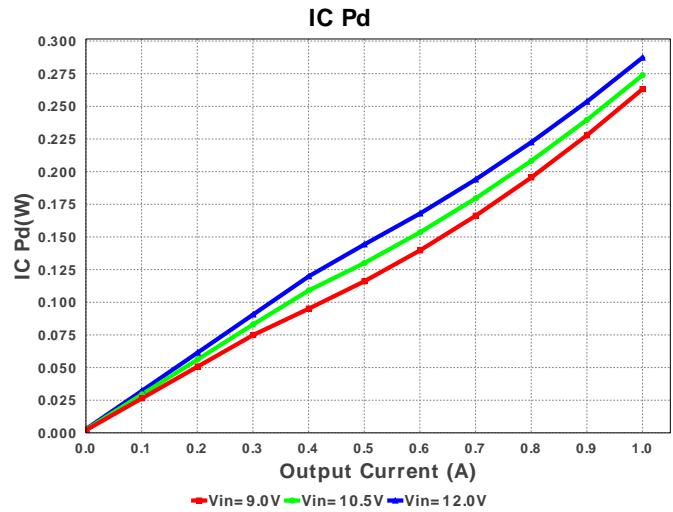
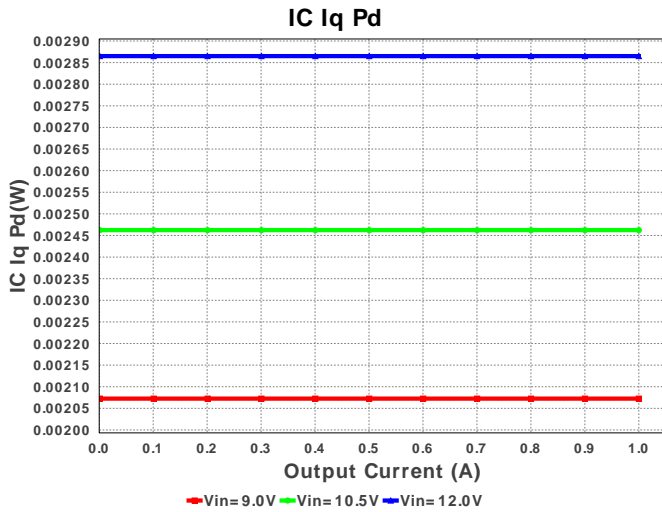



## Operating Values

#	Name	Value	Category	Description
1.	Cin IRMS	520.724 mA	Current	Input capacitor RMS ripple current
2.	Cout IRMS	247.103 mA	Current	Output capacitor RMS ripple current
3.	Iin Avg	444.02 mA	Current	Average input current
4.	L Ipp	855.99 mA	Current	Peak-to-peak inductor ripple current
5.	BOM Count	9	General	Total Design BOM count
6.	FootPrint	122.0 mm <sup>2</sup>	General	Total Foot Print Area of BOM components
7.	Frequency	721.37 kHz	General	Switching frequency
8.	Pout	5.0 W	General	Total output power
9.	Total BOM	\$1.28	General	Total BOM Cost
10.	Vout OP	5.0 V	Op_Point	Operational Output Voltage
11.	Duty Cycle	42.9 %	Op_point	Duty cycle
12.	Efficiency	93.84 %	Op_point	Steady state efficiency
13.	IC Tj	61.319 degC	Op_point	IC junction temperature
14.	ICThetaJA	109.0 degC/W	Op_point	IC junction-to-ambient thermal resistance
15.	IOUT_OP	1.0 A	Op_point	Iout operating point
16.	VIN_OP	12.0 V	Op_point	Vin operating point
17.	Vout p-p	5.765 mV	Op_point	Peak-to-peak output ripple voltage
18.	Cin Pd	542.307 μW	Power	Input capacitor power dissipation
19.	Cout Pd	61.06 μW	Power	Output capacitor power dissipation
20.	IC Iq Pd	2.865 mW	Power	IC Iq Pd
21.	IC Pd	287.33 mW	Power	IC power dissipation
22.	L Pd	39.896 mW	Power	Inductor power dissipation
23.	Total Pd	328.22 mW	Power	Total Power Dissipation

## Design Inputs

#	Name	Value	Description
1.	Iout	1.0	Maximum Output Current
2.	Iout1	1.0	Output Current #1
3.	VinMax	12.0	Maximum input voltage
4.	VinMin	9.0	Minimum input voltage

#	Name	Value	Description
5.	Vout	5.0	Output Voltage
6.	Vout1	5.0	Output Voltage #1
7.	base_pn	TPS562200	Texas Instruments Base Part Number
8.	source	DC	Input Source Type
9.	ta	30.0	Ambient temperature

## Design Assistance

1. TPS562200 Product Folder : <http://www.ti.com/lit/ds/symlink/tps562200.pdf> : contains the data sheet and other resources.

Texas Instruments' WEBENCH simulation tools attempt to recreate the performance of a substantially equivalent physical implementation of the design. Simulations are created using Texas Instruments' published specifications as well as the published specifications of other device manufacturers. While Texas Instruments does update this information periodically, this information may not be current at the time the simulation is built. Texas Instruments does not warrant the accuracy or completeness of the specifications or any information contained therein. Texas Instruments does not warrant that any designs or recommended parts will meet the specifications you entered, will be suitable for your application or fit for any particular purpose, or will operate as shown in the simulation in a physical implementation. Texas Instruments does not warrant that the designs are production worthy.

**You should completely validate and test your design implementation to confirm the system functionality for your application prior to production.**

Use of Texas Instruments' WEBENCH simulation tools is subject to [Texas Instruments' Site Terms and Conditions of Use](#). Prototype boards based on WEBENCH created designs are provided AS IS without warranty of any kind for evaluation and testing purposes and are subject to the terms of the [Evaluation License Agreement](#).