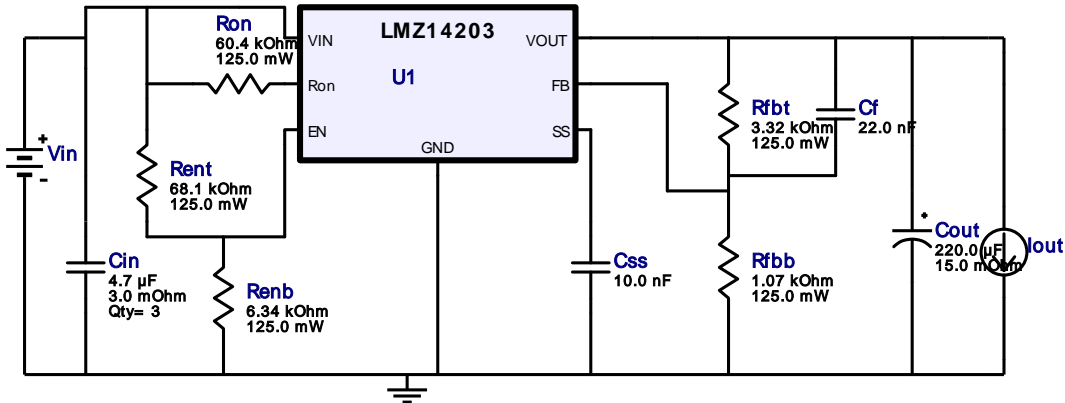
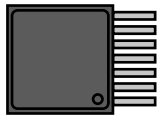

**WEBENCH<sup>®</sup> Design Report**

 Design : 1913968/993 LMZ14203TZ-ADJ/NOPB  
 LMZ14203TZ-ADJ/NOPB 14.0V-22.0V to 3.30V @ 2.0A

**VinMin = 14.0V**  
**VinMax = 22.0V**
**Vout = 3.3V**  
**Iout = 2.0A**

**Electrical BOM**

#	Name	Manufacturer	Part Number	Properties	Qty	Price	Footprint
1.	Cf	Yageo America	CC0805KRX7R9BB223 Series= X7R	Cap= 22.0 nF VDC= 50.0 V IRMS= 0.0 A	1	\$0.01	 0805 7 mm <sup>2</sup>
2.	Cin	MuRata	GRM31CR71H475KA12L Series= X7R	Cap= 4.7 uF ESR= 3.0 mOhm VDC= 50.0 V IRMS= 4.98 A	3	\$0.07	 1206 11 mm <sup>2</sup>
3.	Cout	Panasonic	6SVPE220MW Series= 259	Cap= 220.0 uF ESR= 15.0 mOhm VDC= 6.3 V IRMS= 3.15 A	1	\$0.14	 CAPSMT_62_E61 53 mm <sup>2</sup>
4.	Css	MuRata	GRM216R71H103KA01D Series= X7R	Cap= 10.0 nF VDC= 50.0 V IRMS= 0.0 A	1	\$0.01	 0805 7 mm <sup>2</sup>
5.	Renb	Panasonic	ERJ-6ENF6341V Series= 225	Res= 6.34 kOhm Power= 125.0 mW Tolerance= 1.0%	1	\$0.01	 0805 7 mm <sup>2</sup>
6.	Rent	Panasonic	ERJ-6ENF6812V Series= 225	Res= 68.1 kOhm Power= 125.0 mW Tolerance= 1.0%	1	\$0.01	 0805 7 mm <sup>2</sup>
7.	Rfbb	Panasonic	ERJ-6ENF1071V Series= 225	Res= 1.07 kOhm Power= 125.0 mW Tolerance= 1.0%	1	\$0.01	 0805 7 mm <sup>2</sup>
8.	Rfcb	Panasonic	ERJ-6ENF3321V Series= 225	Res= 3.32 kOhm Power= 125.0 mW Tolerance= 1.0%	1	\$0.01	 0805 7 mm <sup>2</sup>
9.	Ron	Panasonic	ERJ-6ENF6042V Series= 225	Res= 60.4 kOhm Power= 125.0 mW Tolerance= 1.0%	1	\$0.01	 0805 7 mm <sup>2</sup>

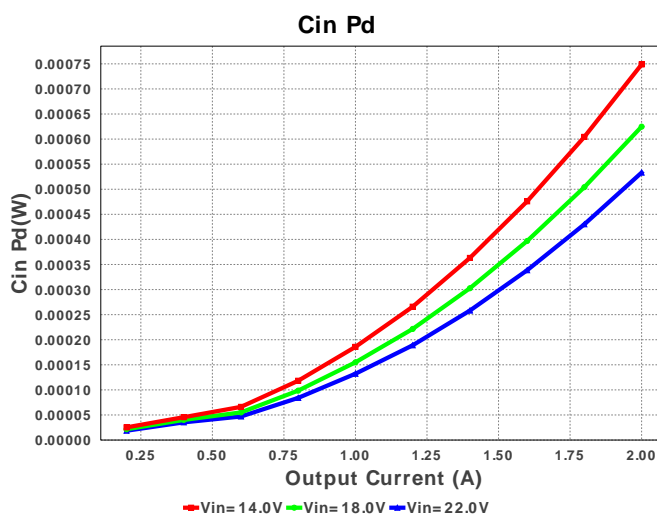
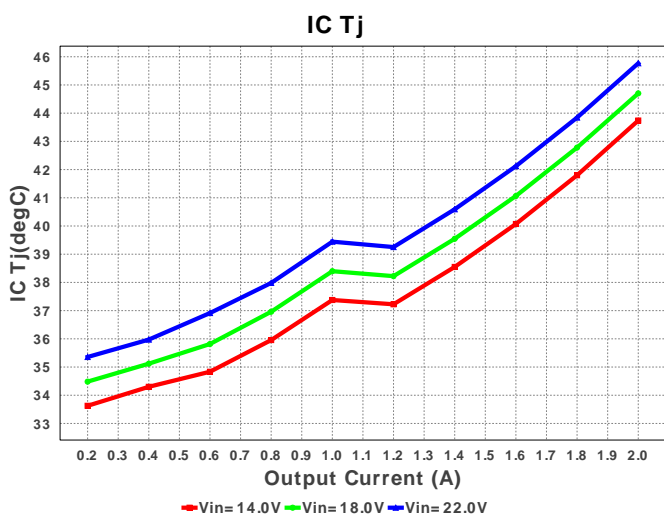
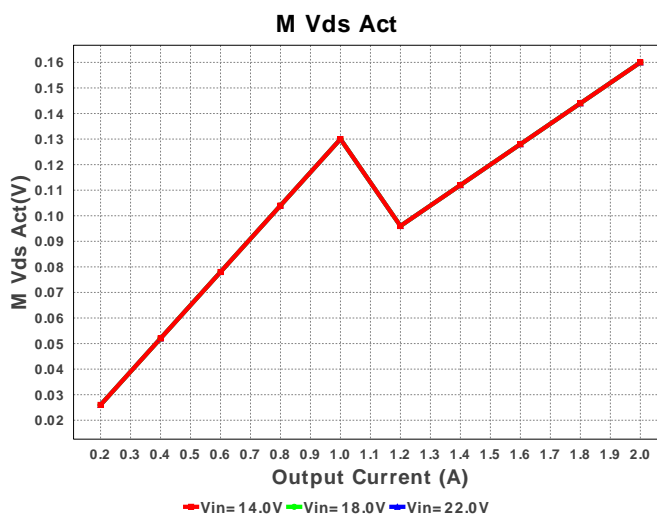
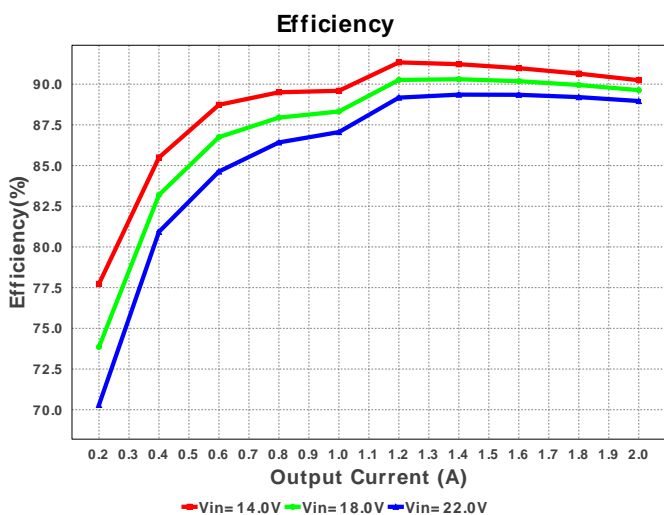
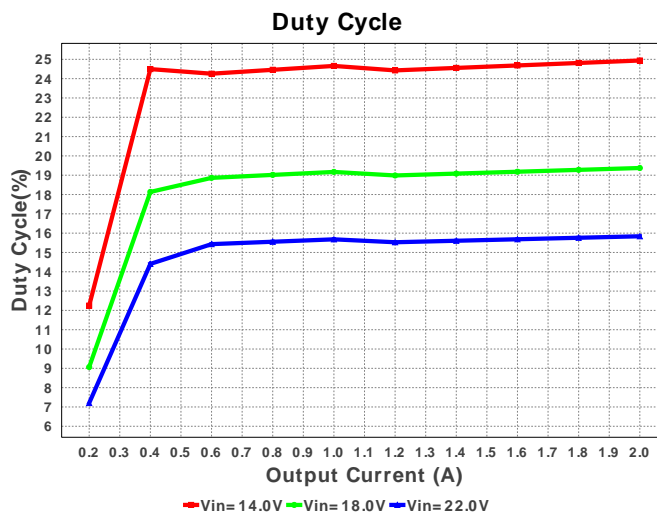
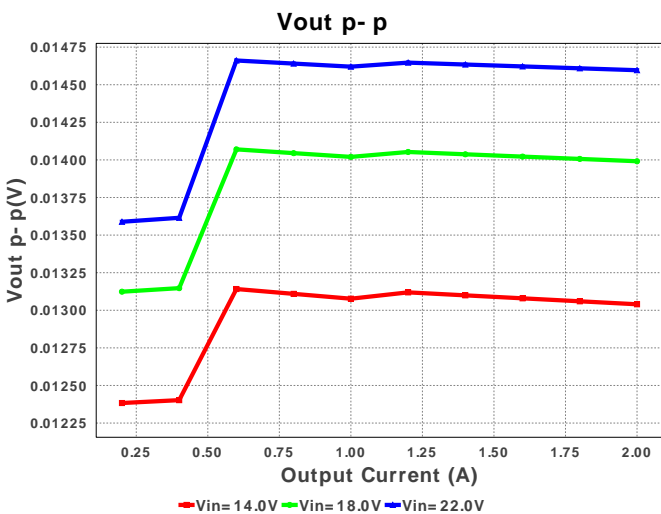
#	Name	Manufacturer	Part Number	Properties	Qty	Price	Footprint
10.	U1	Texas Instruments	LMZ14203TZ-ADJ/NOPB	Switcher	1	\$9.78	 TZA07A 199 mm <sup>2</sup>

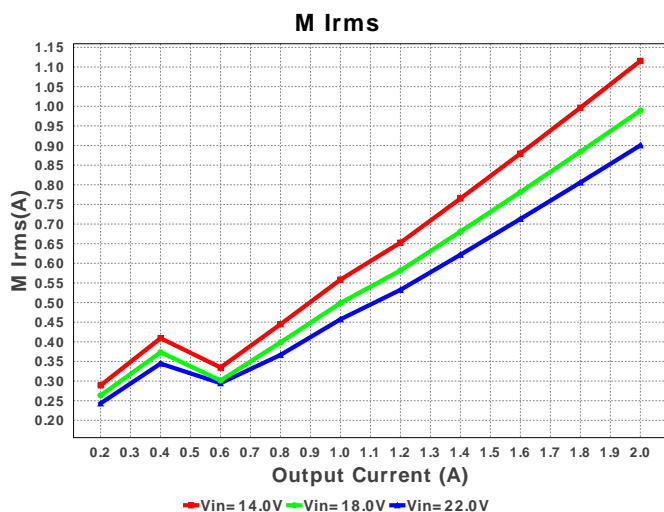
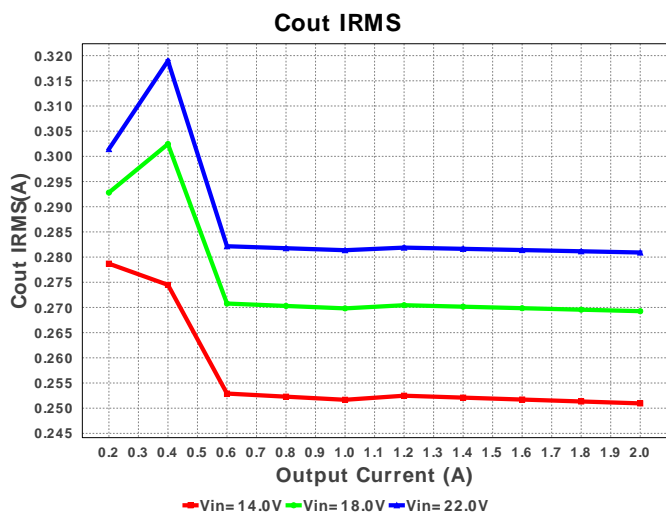
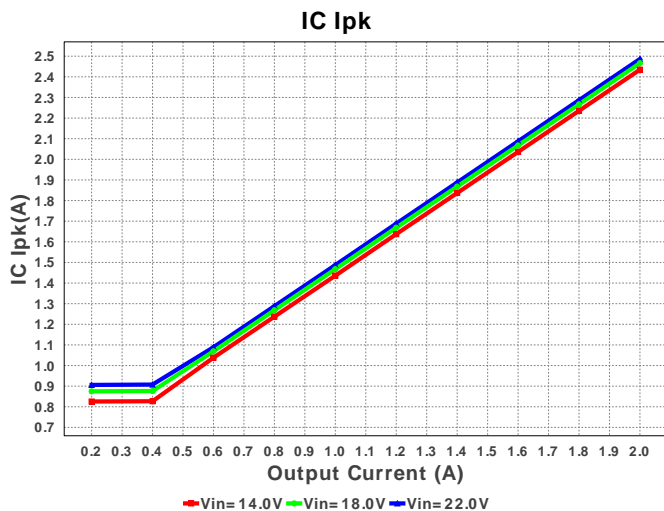
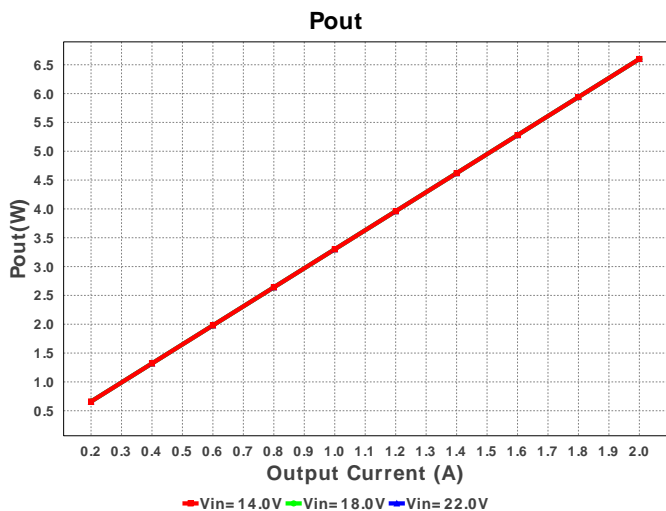
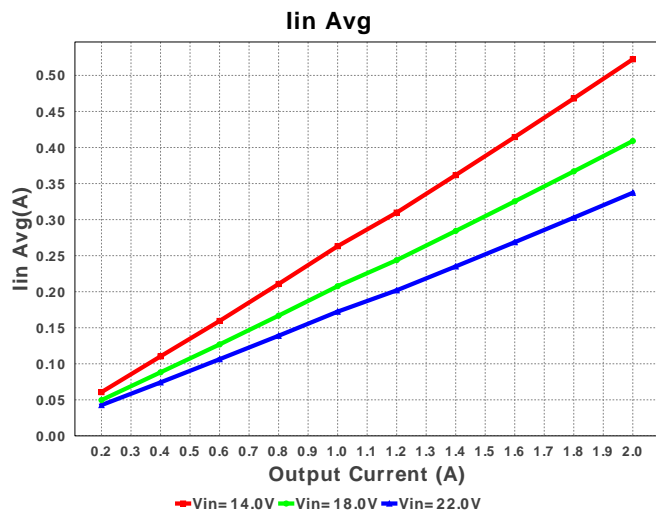
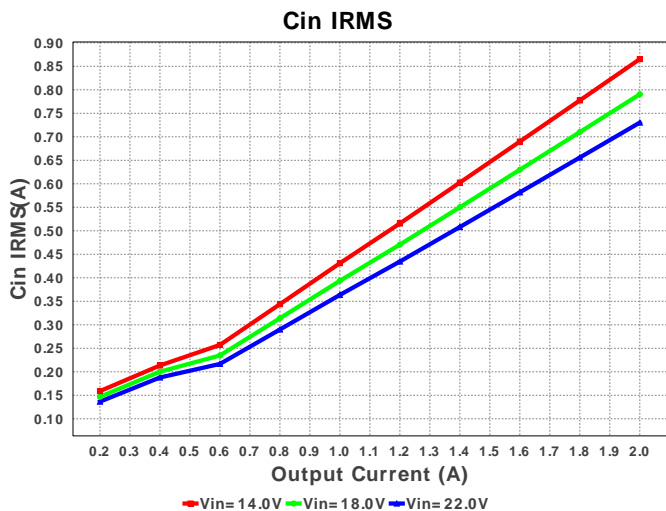

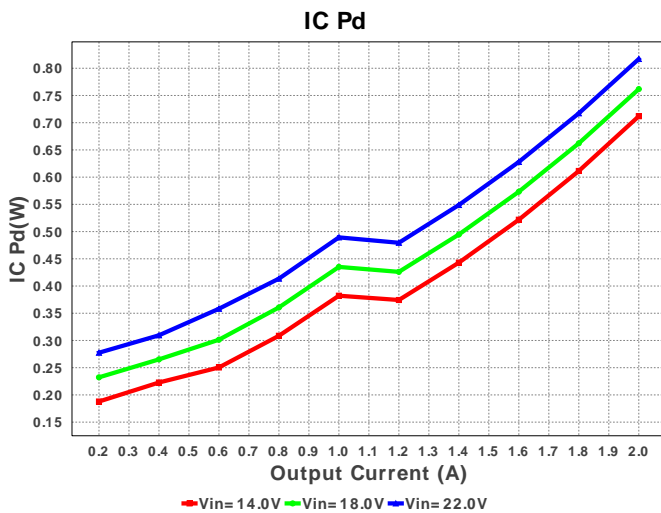
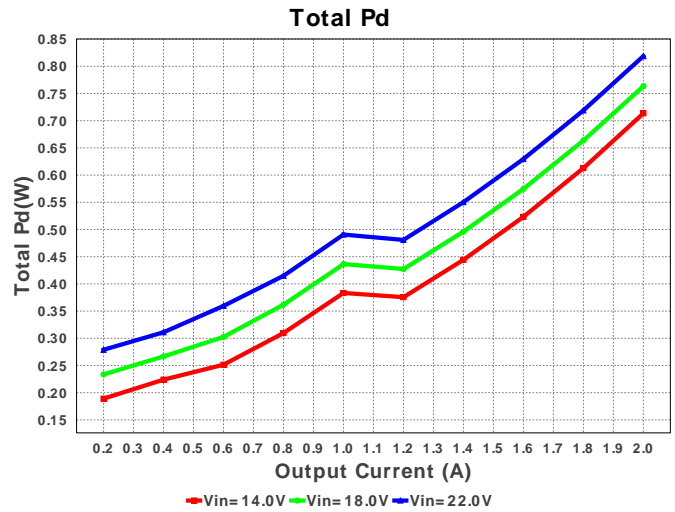
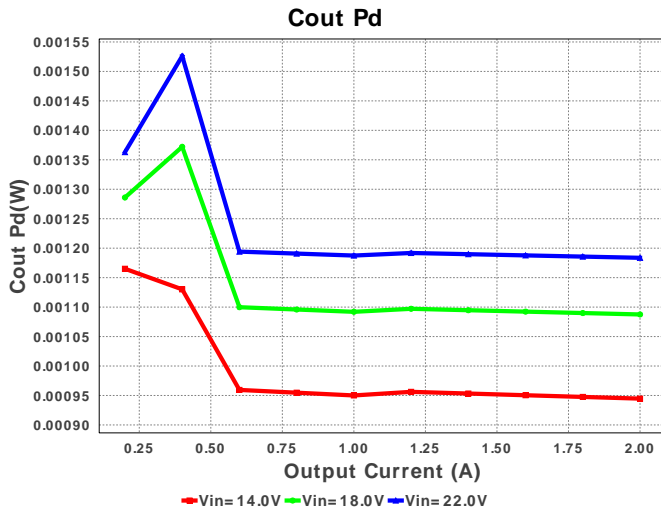



### Operating Values

#	Name	Value	Category	Description
1.	Cin IRMS	730.197 mA	Current	Input capacitor RMS ripple current
2.	Cout IRMS	280.91 mA	Current	Output capacitor RMS ripple current
3.	IC Ipk	2.487 A	Current	Peak switch current in IC
4.	Iin Avg	333.63 mA	Current	Average input current
5.	M1 Irms	891.493 mA	Current	Q lavg
6.	BOM Count	12	General	Total Design BOM count
7.	FootPrint	332.0 mm <sup>2</sup>	General	Total Foot Print Area of BOM components
8.	Frequency	443.759 kHz	General	Switching frequency
9.	IC Tolerance	20.0 mV	General	IC Feedback Tolerance
10.	M Vds Act	160.0 mV	General	Voltage drop across the MosFET
11.	Pout	6.6 W	General	Total output power
12.	Total BOM	\$10.2	General	Total BOM Cost
13.	Vout OP	3.3 V	Op_point	Operational Output Voltage
14.	Duty Cycle	15.838 %	Op_point	Duty cycle
15.	Efficiency	89.92 %	Op_point	Steady state efficiency
16.	IC Tj	44.246 degC	Op_point	IC junction temperature
17.	ICThetaJA	19.3 degC/W	Op_point	IC junction-to-ambient thermal resistance
18.	IOUT_OP	2.0 A	Op_point	Iout operating point
19.	VIN_OP	22.0 V	Op_point	Vin operating point
20.	Vout p-p	14.597 mV	Op_point	Peak-to-peak output ripple voltage
21.	Cin Pd	533.187 μW	Power	Input capacitor power dissipation
22.	Cout Pd	1.184 mW	Power	Output capacitor power dissipation
23.	IC Pd	738.147 mW	Power	IC power dissipation
24.	Total Pd	739.858 mW	Power	Total Power Dissipation

### Design Inputs

#	Name	Value	Description
1.	Iout	2.0	Maximum Output Current
2.	Iout1	2.0	Output Current #1
3.	VinMax	22.0	Maximum input voltage

#	Name	Value	Description
4.	VinMin	14.0	Minimum input voltage
5.	Vout	3.3	Output Voltage
6.	Vout1	3.3	Output Voltage #1
7.	base_pn	LMZ14203	Base Product Number
8.	source	DC	Input Source Type
9.	Ta	30.0	Ambient temperature

## Design Assistance

1. **LMZ14203** Product Folder : <http://www.ti.com/product/LMZ14203> : contains the data sheet and other resources.

Texas Instruments' WEBENCH simulation tools attempt to recreate the performance of a substantially equivalent physical implementation of the design. Simulations are created using Texas Instruments' published specifications as well as the published specifications of other device manufacturers. While Texas Instruments does update this information periodically, this information may not be current at the time the simulation is built. Texas Instruments does not warrant the accuracy or completeness of the specifications or any information contained therein. Texas Instruments does not warrant that any designs or recommended parts will meet the specifications you entered, will be suitable for your application or fit for any particular purpose, or will operate as shown in the simulation in a physical implementation. Texas Instruments does not warrant that the designs are production worthy.

**You should completely validate and test your design implementation to confirm the system functionality for your application prior to production.**

Use of Texas Instruments' WEBENCH simulation tools is subject to [Texas Instruments' Site Terms and Conditions of Use](#). Prototype boards based on WEBENCH created designs are provided AS IS without warranty of any kind for evaluation and testing purposes and are subject to the terms of the [Evaluation License Agreement](#).