

C2000™ Real-Time Microcontrollers



The TMS320C2000™ MCU Advantage

The world is changing. Devices are getting smarter, modern technology is spreading throughout the globe, and advances are allowing us to reach new heights like never before – all with an increased focus on green energy and efficiency. But, that doesn't have to mean increased costs or longer development cycles.

With a 32-bit architecture, advanced peripherals, analog integration, and package sizes from 32 to 256 pins, the C2000™ MCU family enables uncompromising performance and real-time control in a variety of applications. Unique, feature-filled peripherals include an unparalleled on-chip 12.5 MSPS ADC, high-resolution PWMs, enhanced capture units, and much more. The TMS320C28x™ 32-bit core features a single-cycle 32×32-bit hardware multiplier and single-cycle atomic instruction execution. Furthermore, C2000 MCU's unique controlCARD-based development tools in combination with the controlSUITE™ software package help to dramatically speed development time with an intuitive and easy-to-use development platform. Explore our wide range of products and configurations to find the perfect solution for your designs.

Piccolo™ 32-Bit Microcontrollers: Small Package, Big Performance

The TMS320F2802x/2803x/2806x Piccolo family of C2000 MCUs provides a low-cost, highly integrated processor solution, enabling processor-intensive real-time control in cost-sensitive applications. Piccolo processors support speeds of up to 80 MHz and up to 256kB of integrated flash memory, dedicated high-resolution PWMs, powerful ADCs, analog comparators and communications interfaces in a cost-sensitive mixed-signal device. Integrated floating-point support in select Piccolo devices brings the ease of floating-point development to cost-sensitive applications. An optional floating-point co-processor called the Control Law Accelerator (CLA) – with independent access to feedback and feedforward peripherals – provides a parallel control loop path to augment the main CPU. The addition of a Verterbi Complex Math Unit (VCU) enables PLC applications and further speeds complex math processing. F2806x MCUs also include a floating-point unit (FPU) for increased performance and ease of use. Available in multiple package and peripheral options, the Piccolo family is the ultimate combination of performance, integration, size and low cost. www.ti.com/piccolo

Delfino™ Microcontrollers: High-Performance, Floating-Point Microcontrollers

The Delfino F2833x and C2834x series of 32-bit microcontrollers bring leading floating-point performance and integration to high-performance, real-time

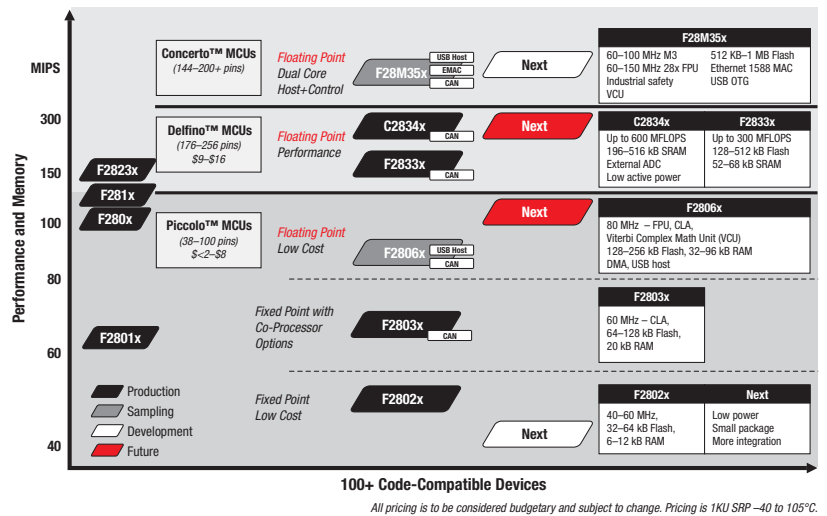

control applications. Delfino MCUs support speeds of up to 300 MHz, up to 512KB of integrated flash or 516KB internal RAM, high-resolution PWMs, integrated 12.5 MSPS ADC or external ADC interface, and a wide variety of communications interfaces. Higher performance enables greater intelligence and efficiency in high-end real-time control applications.

With a high-performance core, control-optimized peripherals, and scalable development platform, the Delfino line of microcontrollers can reduce system cost, increase system reliability, and boost performance for applications such as industrial power electronics, power delivery, renewable energy, and smart sensing. www.ti.com/delfino

Concerto™ Microcontrollers: Connectivity and Control, No Compromise

The Concerto F28M35x series brings together connectivity and control by combining the ARM® Cortex™-M3 core with C2000's C28x core, all in one device. Concerto enables applications such as solar inverters and industrial control to keep the benefits of separate communications and control processing while maintaining a single-chip solution. Concerto MCUs support up to 150-MHz operation in the C28x control-oriented core and up to 100-MHz operation on the ARM Cortex-M3 communications-oriented core. Memory options scale up to 1MB Flash and 132KB RAM. Communications include Ethernet, USB, CAN, I²C, SPI, SCI, and McBSP. Lower system cost, enable safety certification, and achieve the full benefits industry-leading real-time control and communications, without compromise. www.ti.com/concerto

Visit the TI E2E™ Community

Join fellow engineers at the TI E2E Community web site, where you can find training videos, blogs, and an active forum to find the answers to your questions. With a rapidly growing user base, the E2E community will serve as a nexus for all things TI. www.ti.com/c2000community

Videos – Watch videos on training, engineering topics, and TI events. Visit the E2E Videos section to learn not only about TI products but also new technologies and trends.

Blogs – Read blog posts about everything from new discoveries to rising cases of “net lag.” Find blogs with the musings of some of the brightest minds at TI.

Forums – Get help at the TI E2E forums. Perused by engineers both inside and outside TI, there's someone out there who understands your problems. And if you're feeling smart, don't hesitate to return the favor.

Memory Bus and Fast Interrupts

With 96 interrupt vectors, C2000 MCUs offer the utmost flexibility in your projects. Designed for real-time control, the C28x™ microcontroller core has fast interrupts that allow context switches in as fast as 10 cycles.

Using a modified Harvard architecture, the 32-bit data and peripheral buses ensure that the core, memory, and peripherals interface efficiently. Secure flash, RAM, and ROM protect your intellectual property from unwelcome eyes. A six-channel DMA is available on select devices.

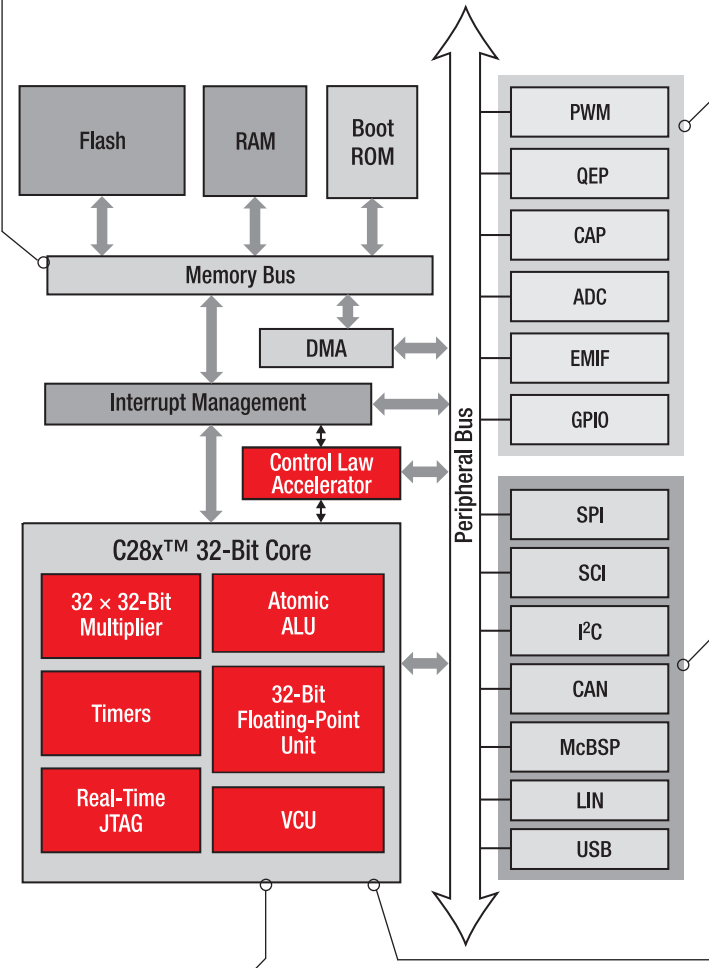

Unique Peripherals

The C2000 MCU device platform leads in offering unique peripheral interfaces that improve system performance and flexibility.

- The C2000 microcontroller platform offers as many as 16 analog input channels with dual sample and hold and 12-bit ADC sampling up to 12.5 MSPS – the industry’s leading embedded ADC.
- Enhanced capture units based on 32-bit timers allow high-accuracy sensing and more flexibility.
- High-resolution PWM generators provide unprecedented precision for controlling power electronics by offering 150-ps resolution and down to 65 ps for 300 MHz Delfino devices. Additionally, fully programmable trip-zone detection and dead-time generators offer complete system protection from faults and surges.

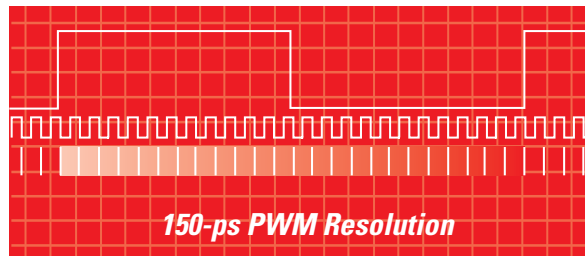

Communication Interfaces

C2000 microcontrollers include a mix of communication interfaces to talk to system components.

C2000 MCU 32-Bit Architecture

The C28x microcontroller generation is optimized to deliver the highest-performance control solution with the best time to market.

- Floating-point and fixed-point microcontrollers
- Up to 300 MIPS or 600 MFLOPS
- A mix of 16- and 32-bit instructions
- Best-in-class compiler efficiency
- Single-cycle 32×32-bit multiply accumulate
- Software compatibility across entire C2000 MCU platform

The Floating-Point Advantage

The new Piccolo™ TMS320F2806x and Delfino™ MCU TMS320F283xx series feature an integrated hardware floating-point unit, offering native single-precision floating-point processing, ease of use and better integration with additional simulation and development tools. The Control Law Accelerator co-processor (CLA) in select Piccolo 32-bit microcontrollers brings floating point to an even wider range of applications.

Compatible with all C2000 devices, the IQMath library eliminates the scaling and saturation burden of fixed-point math, giving you adjustable global or local range and resolution, which speeds development and provides easier tuning and re-use of systems. IQMath is fully supported by the C28x MCU compiler and includes dozens of arithmetic, trigonometric, and numerical conversion functions. www.ti.com/iqmath

C2000 Key Applications

- Digital power
- Digital motor control
- Renewable energy
- Power line communications
- Lighting
- Automotive
- Precision sensing and control

TMS320C2000™ Microcontrollers

Table with columns: Device (TMS320x), Processor (Speed, VCU, DMA, CLA), Memory (RAM, Flash, ROM, PWM Ch), Control Interfaces (HiRes PWM, Quadrature Encoder, Event Captures, Timers*, 12-Bit ADC), Communication Ports (USB, McBSP, PC, UART/SCI, SPI, Lin, CAN, External Memory Bus), Core Supply (Volts), GPIO Pins, On-Chip OSC/Regulator, Pin/Package, and 1 KU Pricing.

All devices available with AEC-Q100 (125°C) maximum temperature range.

*Timers include CPU timers, PWM timers, eCAP timers and Watchdog timers.

*Prices are quoted in U.S. dollars and represent 2011 suggested resale pricing for baseline packages. All prices are subject to change.

New products are listed in bold red.

All devices available in Pb-Free/Green packaging.

ROM devices are available. Please contact TI sales for more information.

Introducing Concerto™ MCUs: Connectivity without compromise

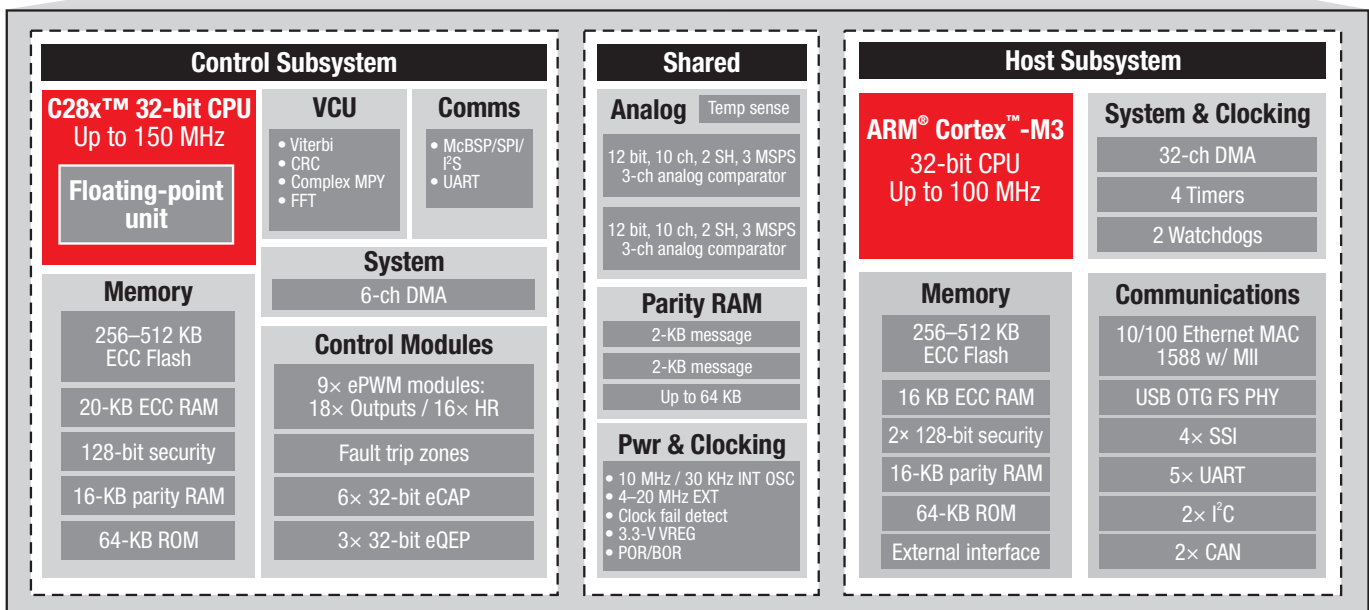

Real-Time Control TI 32-bit F28x with FPU

Processing and control

- Industry leading computational performance
- Lowest control loop latency
- Robust control software support
- Fine-tuned control architecture

Precision peripherals

- Flexible, highest resolution, best synchronization PWMs
- High-speed precision-synchronized analog
- Flexible power line modem solution



Host MCU ARM® 32-bit Cortex™-M3

Ecosystem

- Operating systems
- Middleware
- Software infrastructure

Rich Communications

- Ethernet
- USB
- CAN, serials
- Wireless
- Various field busses

Application Layer

- Sequencing, profiles
- Diagnostics, monitoring

Industry's #1 MCU for power electronics and power-line modem

Industry's #1 MCU for general purpose and communication

Concerto™ Microcontrollers																												
Part Number	Processor				Memory		Control Interfaces							Communication Ports							Other							
	Speed (MHz)	FPU	VCU	DMA	RAM (KB)	Flash (KB)	PWM Chs*	HR PWM	Timers	Event Captures	QEP/QEI	ADC Resolution	ADC Inputs	ADC MSPS	Comparators	USB (OTG)	ENET	SPI	SCI	CAN	IC	McBSP	O-Pin OSCs	I/O Pins	I/O / Supply Voltage (V)	Other Packaging	Ext. Temp (-40 to 125°C)	10kU SRP (U.S. \$)
5-Series: Entry																												
F28M35E20B	60/60	Yes	Yes	Yes	72	512	24	16	25	6	3	2× 12-bit	20	4.6	6	–	–	5	6	2	3	1	2	64	3.3/3.3	144 HTQFP	Yes	6.71
F28M35E20C	60/60	Yes	Yes	Yes	72	512	24	16	25	6	3	2× 12-bit	20	4.6	6	1	Yes	5	6	2	3	1	2	64	3.3/3.3	144 HTQFP	Yes	8.15
F28M35E22B	60/60	Yes	Yes	Yes	136	512	24	16	25	6	3	2× 12-bit	20	4.6	6	–	–	5	6	2	3	1	2	64	3.3/3.3	144 HTQFP	Yes	8.64
F28M35E22C	60/60	Yes	Yes	Yes	136	512	24	16	25	6	3	2× 12-bit	20	4.6	6	1	Yes	5	6	2	3	1	2	64	3.3/3.3	144 HTQFP	Yes	10.08
F28M35E32B	60/60	Yes	Yes	Yes	136	768	24	16	25	6	3	2× 12-bit	20	4.6	6	–	–	5	6	2	3	1	2	64	3.3/3.3	144 HTQFP	Yes	9.26
F28M35E32C	60/60	Yes	Yes	Yes	136	768	24	16	25	6	3	2× 12-bit	20	4.6	6	1	Yes	5	6	2	3	1	2	64	3.3/3.3	144 HTQFP	Yes	10.70
F28M35E50B	60/60	Yes	Yes	Yes	72	1024	24	16	25	6	3	2× 12-bit	20	4.6	6	–	–	5	6	2	3	1	2	64	3.3/3.3	144 HTQFP	Yes	8.88
F28M35E50C	60/60	Yes	Yes	Yes	72	1024	24	16	25	6	3	2× 12-bit	20	4.6	6	1	Yes	5	6	2	3	1	2	64	3.3/3.3	144 HTQFP	Yes	10.32
F28M35E52B	60/60	Yes	Yes	Yes	136	1024	24	16	25	6	3	2× 12-bit	20	4.6	6	–	–	5	6	2	3	1	2	64	3.3/3.3	144 HTQFP	Yes	9.84
F28M35E52C	60/60	Yes	Yes	Yes	136	1024	24	16	25	6	3	2× 12-bit	20	4.6	6	1	Yes	5	6	2	3	1	2	64	3.3/3.3	144 HTQFP	Yes	11.28
5-Series: Mid-end																												
F28M35M20B	75/75	Yes	Yes	Yes	72	512	24	16	25	6	3	2× 12-bit	20	5.8	6	–	–	5	6	2	3	1	2	64	3.3/3.3	144 HTQFP	Yes	9.12
F28M35M20C	75/75	Yes	Yes	Yes	72	512	24	16	25	6	3	2× 12-bit	20	5.8	6	1	Yes	5	6	2	3	1	2	64	3.3/3.3	144 HTQFP	Yes	10.56
F28M35M22B	75/75	Yes	Yes	Yes	136	512	24	16	25	6	3	2× 12-bit	20	5.8	6	–	–	5	6	2	3	1	2	64	3.3/3.3	144 HTQFP	Yes	10.08
F28M35M22C	75/75	Yes	Yes	Yes	136	512	24	16	25	6	3	2× 12-bit	20	5.8	6	1	Yes	5	6	2	3	1	2	64	3.3/3.3	144 HTQFP	Yes	11.52
F28M35M32B	75/75	Yes	Yes	Yes	136	768	24	16	25	6	3	2× 12-bit	20	5.8	6	–	–	5	6	2	3	1	2	64	3.3/3.3	144 HTQFP	Yes	10.70
F28M35M32C	75/75	Yes	Yes	Yes	136	768	24	16	25	6	3	2× 12-bit	20	5.8	6	1	Yes	5	6	2	3	1	2	64	3.3/3.3	144 HTQFP	Yes	12.14
F28M35M50B	75/75	Yes	Yes	Yes	72	1024	24	16	25	6	3	2× 12-bit	20	5.8	6	–	–	5	6	2	3	1	2	64	3.3/3.3	144 HTQFP	Yes	10.32
F28M35M50C	75/75	Yes	Yes	Yes	72	1024	24	16	25	6	3	2× 12-bit	20	5.8	6	1	Yes	5	6	2	3	1	2	64	3.3/3.3	144 HTQFP	Yes	11.76
F28M35M52B	75/75	Yes	Yes	Yes	136	1024	24	16	25	6	3	2× 12-bit	20	5.8	6	–	–	5	6	2	3	1	2	64	3.3/3.3	144 HTQFP	Yes	11.28
F28M35M52C	75/75	Yes	Yes	Yes	136	1024	24	16	25	6	3	2× 12-bit	20	5.8	6	1	Yes	5	6	2	3	1	2	64	3.3/3.3	144 HTQFP	Yes	12.72
5-Series: High-end																												
F28M35H20B	150/75 or 100/100	Yes	Yes	Yes	72	512	24	16	25	6	3	2× 12-bit	20	5.8	6	–	–	5	6	2	3	1	2	64	3.3/3.3	144 HTQFP	Yes	11.76
F28M35H20C	150/75 or 100/100	Yes	Yes	Yes	72	512	24	16	25	6	3	2× 12-bit	20	5.8	6	1	Yes	5	6	2	3	1	2	64	3.3/3.3	144 HTQFP	Yes	13.20
F28M35H22B	150/75 or 100/100	Yes	Yes	Yes	136	512	24	16	25	6	3	2× 12-bit	20	5.8	6	–	–	5	6	2	3	1	2	64	3.3/3.3	144 HTQFP	Yes	12.72
F28M35H22C	150/75 or 100/100	Yes	Yes	Yes	136	512	24	16	25	6	3	2× 12-bit	20	5.8	6	1	Yes	5	6	2	3	1	2	64	3.3/3.3	144 HTQFP	Yes	14.16
F28M35H32B	150/75 or 100/100	Yes	Yes	Yes	136	768	24	16	25	6	3	2× 12-bit	20	5.8	6	–	–	5	6	2	3	1	2	64	3.3/3.3	144 HTQFP	Yes	13.34
F28M35H32C	150/75 or 100/100	Yes	Yes	Yes	136	768	24	16	25	6	3	2× 12-bit	20	5.8	6	1	Yes	5	6	2	3	1	2	64	3.3/3.3	144 HTQFP	Yes	14.78
F28M35H50B	150/75 or 100/100	Yes	Yes	Yes	72	1024	24	16	25	6	3	2× 12-bit	20	5.8	6	–	–	5	6	2	3	1	2	64	3.3/3.3	144 HTQFP	Yes	12.96
F28M35H50C	150/75 or 100/100	Yes	Yes	Yes	72	1024	24	16	25	6	3	2× 12-bit	20	5.8	6	1	Yes	5	6	2	3	1	2	64	3.3/3.3	144 HTQFP	Yes	14.40
F28M35H52B	150/75 or 100/100	Yes	Yes	Yes	136	1024	24	16	25	6	3	2× 12-bit	20	5.8	6	–	–	5	6	2	3	1	2	64	3.3/3.3	144 HTQFP	Yes	13.92
F28M35H52C	150/75 or 100/100	Yes	Yes	Yes	136	1024	24	16	25	6	3	2× 12-bit	20	5.8	6	1	Yes	5	6	2	3	1	2	64	3.3/3.3	144 HTQFP	Yes	15.36

All devices include one 2-pin oscillator and POR/BOR.

New products are listed in bold red.

*PWM channels include output from ePWM modules (2 per module) and eCAP. The eCAP can be configured as a PWM when not used for capture.

Digital Power

C2000 microcontrollers bring a new range of possibilities in digital power management and power control. A digitally controlled system based on a C2000 MCU overcomes many of the analog power supply challenges and provides significant benefits to most power supplies, such as improved efficiency, added functions and features, and increased reliability. For example, C2000 microcontroller-driven power supplies are reaching unprecedented efficiency levels, especially at light loads. TI provides digital power algorithms and user-friendly software libraries that can be adapted to different topologies and voltage power levels, allowing for faster time to market. www.ti.com/digitalpower

controlsUITE™ software includes multiple control methods and multiple topologies through modular software for C2000 microcontrollers at no cost. www.ti.com/controlsuite

Why go for digital power?

Reduces costs

- Tunable platforms lead to new products quicker
- Calibration, better noise and temperature immunity
- Reduced board area and parts count

Higher reliability

- Built-in supervision
- Intelligent diagnostics, failure prediction, reporting capability

Higher quality

- Adaptive efficiency across load range
- Flexibility through programmability
- Calibration at final functional test
- Less sensitive to drift and better noise immunity
- Parameter monitoring for continual quality improvement
- Proven concept in mature digital motor control market

Key Applications

- Switch-mode power supplies
- Uninterruptible power supplies
- AC/DC rectifiers
- Hybrid vehicles
- Digital TVs
- DC-DC modules or POLs:
 - Buck or boost
 - Half-bridge
 - Full-bridge
 - Multiphase interleaved
- Communication systems in:
 - Server farms
 - Base stations
 - Telecom/Consumer equipments

Tools and Software for Digital Power Applications

High voltage development kits and digital power software libraries to jump start designs!



Power Factor Correction Kit – \$249

- 2-phase interleaved PFC
- 300W, up to 400V DC output
- Isolated JTAG for real-time debug
- Comes with Piccolo™ F28027 controller card



Phase Shifted Full Bridge – \$550

- Up to 400VDC input
- 600W 12VDC output
- Supports peak current mode with slope compensation on chip
- Comes with Piccolo F28027 controller card



Bridgeless PFC Kit – \$450

- 2-phase interleaved PFC
- 300W, up to 400V DC output
- Isolated JTAG for real-time debug
- Comes with Piccolo F28035 controller card



Resonant LLC Kit – \$400

- Up to 400VDC input
- 360W 12VDC output
- Experiment with OCP, OVP and UVP
- Comes with Piccolo F28027 controller card

Digital Motor Control

C2000 microcontrollers reduce the overall cost of motor control systems by providing the integration and performance necessary to implement advanced control techniques such as sensorless vector control of three-phase motors. Using the more processor-intensive vector control, for example, allows developers to reduce the size and cost of the motors and power electronics. With C2000 microcontrollers, developers can now capitalize on the latest advancements in motor designs and control techniques. www.ti.com/c2000dmc

Key Applications

- Variable-speed drives
- Servo drives
- Appliance motors
- HVAC compressors and blowers
- Industrial pumps
- Electric power steering
- Soft starters
- White goods

Motor Control Libraries

- AC induction motors
- PMSM motors
- Brushless DC motors
- Solutions for both sensed and sensorless systems

Dual Motor Control and PFC Developer's Kit – \$399



- Power factor correction plus dual- or single-axis motor control with a single Piccolo™ device
- Sensorless field oriented control
- Isolated onboard USB JTAG emulation
- Single-motor version also available for \$369

C2000 Digital Motor Control Gives You MORE

C2000-based motor-control systems enable energy and cost savings throughout products.

- Variable speed control → MORE efficient motors
- Field-oriented control → MORE efficient control
- Space vector PWM → MORE efficient power stage
- Sensor-less control → MORE cost effective
- Multi-axis control → MORE motors per controller
- Integrated digital PFC → MORE system functions
- Meeting IEC standards → MORE reliable and robust
- Broadest MCU portfolio → MORE products, one platform

Software and hardware demonstrating all listed advantages can be found at www.ti.com/c2000dmc

High-Voltage PFC and MC Developer's Kit – \$599



- 1.5KW, 350V three-phase motor driver stage
- 750W 110–220 Vac PFC stage
- CAN control ACI, PMSM and BLDC
- Motors of each type available directly from TI (sold separately)
- Isolated CAN and UART interfaces

Automotive

The automotive industry is constantly looking for new ways to make their cars safer, more reliable, and more efficient. The powerful PWM modules and analog ADC integrated in C2000 microcontroller devices can be used in applications such as collision avoidance and electronically-controlled interfaces.

The industry is also looking at a shift toward hybrid and fully electric vehicles, and C2000 MCUs provide a low-cost solution to many aspects of HEV/EV operation. With a powerful DSP-based core, a variety of communication protocols including LIN and CAN, and automotive AEC-Q100 qualification (–40° to 125°C), C2000 microcontrollers work to complete your automotive designs. www.ti.com/hev

HEV Benefits

- Reconfigurable constant voltage/current/power charging mode
- Optimized battery charging to extend battery life and performance
- Communication via PLC for smart charging
- Improved SOC/SOH estimation for optimal battery usage



Key Applications

- Automotive radar and collision avoidance
- Electric power steering
- Drive-by-wire
- Power conversion
- Hybrid Electric Vehicle/Electric Vehicle (HEV/EV)
 - Off-line battery charger
 - DC/DC power conversion
 - Battery management system
 - Electric motor inverter

Tools and Software

- Hardware reference designs
 - Start/Stop system – 4-phase interleaved boost
 - Motor control board for small task-oriented vehicles (STOV)
 - Automotive headlamp
- controlSUITE™ software

Renewable Energy

Environmental concerns and rising energy prices are fueling a rapid growth in renewable energy sources. C2000 microcontrollers can play a pivotal role in enabling the development of such systems. Powerful C2000 processors can provide maximum efficiency by quickly executing real-time control-loop algorithms at high frequency and running multiple maximum power point tracking algorithms in parallel. C2000 MCUs can also manage intelligent switching between the main grid and auxiliary batteries to allow seamless integration of alternative energy sources. www.ti.com/solar

Key Applications

- Solar inverters
- Wind turbine inverters
- Deep-cycle battery management
- Hydropower
- DC/AC converters
- Large-scale power grids
- Stand-alone power systems

Benefits

Single C2000 MCU has performance and peripherals to control entire system

A C2000 MCU can run intelligent battery charging algorithms along with sophisticated grid management

Real-time control of DC/DC and DC/AC power conversion stages

Maximize power output across varying load and shade conditions

Increased efficiency reducing cost per kilowatt

Multiple PWM time bases allow the control of different turbine types

Easy system networking with I²C, CAN, SPI, and UART peripherals

Tools and Software

- Renewable Energy Developer's Kit
- Digital power kits
- Signal processing libraries

Renewable Energy Developer's Kit – \$349

- Digitally controlled DC/AC inverter with a maximum power output of 45 watts
- Capable of syncing to an external AC line and managing a back-up battery
- Provides the necessary current and voltage measurements to implement advanced algorithms, such as maximum power point tracking
- Comes with an F2808 controlCARD



Lighting

LED lighting is increasingly becoming the dominant lighting technology due to its inherent efficiency, safety, configurability, and aesthetic benefits. Likewise, C2000 microcontrollers are an ideal solution for many LED lighting applications. With an optimized DSP core and powerful peripherals, C2000 microcontrollers provide the processing capability and integration to drive low-cost, dynamic, and energy-efficient lighting systems. With just a single, low-cost Piccolo™ MCU, high efficiency digital power conversion, dynamic multi-string LED lighting control, and advanced communications can be implemented in a lighting system. www.ti.com/led

Key Applications

- Industrial & commercial lighting
- Building lighting
- Street lighting
- Stage lighting
- Automotive lighting
- Large infrastructure lighting
- Intelligent lighting

DC/DC LED Lighting Developer's Kit – \$399

- Eight independent 10-watt LED driver stages
- Buck or boost DC/DC power stage
- Digital control of DC/DC power stage and LED driver stages with a single Piccolo™ MCU
- Includes Piccolo F28035 controlCARD



Multi-DC/DC Color LED Kit – \$499

- Eight independent DC/DC Boost/SePIC power stages
- Implements color mixing
- Digital control of eight DC/DC power stages and eight LED driver stages with a single Piccolo MCU
- Includes Piccolo F28027 controlCARD



Benefits

Increase operating efficiency across lighting conditions

Single design for multiple lighting fixture implementations

Add intelligence with advanced communications protocols such as Power-Line Communications (PLC), DALI, DMX, KNX, etc.

Precise LED intensity, dimming, and color mixing through on-chip high-resolution PWM and ADC peripherals

Reduce cost through integration of all major control systems into a single MCU

Easy field upgrades and dynamic on-the-fly adjustments

Easy implementation of advanced features such as temperature sensing and correction, dimming scheduler, aging compensation, etc.

Power-Line Communications

Power-line communications (PLC) transmit data over an existing high-voltage power line instead of requiring dedicated cabling. Although the technology has been used for decades, recent concepts and ideas have opened the door to new innovations driven by power line communication. C2000 microcontrollers are an ideal platform for power-line networked applications because the performance, large on-chip memory, and integrated peripheral interfaces provide a single-chip solution for control and PLC functions. Additionally, with unique on-chip IP such as the Verterbi Complex Math Unit (VCU), C2000 MCUs are tuned for power-line communications, offering unparalleled performance in a cost-sensitive package. TI has developed freely available PLC software libraries and hardware reference designs which provide a flexible platform to quickly develop and test robust PLC implementations. With a flexible PLC development platform and PLC-optimized C2000 MCUs, TI provides industry-leading solutions for PLC development. www.ti.com/plc

Key Applications

- Lighting
- Solar
- Metering
- Industrial controls
- Ballast
- Security gates/cameras
- Motor control

C2000 Power-Line Modem Developer's Kit – \$599

- Two PLC modems
- PLC software supporting OFDM (PRIME, G3, FlexOFDM) and SFSK communication
- Two F28069 controlCARDS included



Benefits

Single C2000 MCU has the performance and peripherals to control the entire system

PLC systems controlled with software allow multiple standard support and easy protocol updating

Software-based system allows modulation scheme to be changed in software

Integrated system communication interfaces: I²C, CAN, SPI, UART, LIN

Precision Sensing and Control

The growing requirements to add active intelligence and functionality to sensing and measurement applications make microcontrollers that enable a high-precision response very desirable. The benefits of a DSP-based core (filtering and high-performance calculations) combined with the best features of an MCU (easy development and low-cost integration) allow for innovative implementations and advancements of common systems. The C2000 platform is composed of components that can improve almost any application that requires precision sensing and control.

Key Applications

- RFID readers
- Musical effects
- Alarm systems
- Robots
- Motor systems
- Medical
- Bar-code scanners
- Pressure/torque/inertial sensors
- Capacitive/piezoresistive sensors
- Thermal and laser control for optical networks
- Radar sensing

Tools and Software

- Experimenter's Kit
- Peripheral Explorer Kit
- Software libraries

Peripheral Explorer Kit – \$179

- Easily learn how to use all of the advanced peripherals on a C2000 MCU
- Ready-to-run software and hardware
- Comes with an F28335 controlCARD
- Includes on-board USB JTAG emulation
- Includes C2000 teaching CD-ROM

Benefits

Accurate measurements

Precise outputs and control

Minimize cost and improve reliability

Enabling Features

- Fastest on-chip ADC on the market – up to 12.5 MSPS with dual sample-and-hold to allow concurrent measurements
- Multiple high-resolution PWM modules provide step resolution at 150 ps
- Fully configurable PWM outputs allow the creation of almost any output waveform with any synchronization scheme
- 32-bit enhanced captures with four event time stamps
- Dual integrated high-speed oscillators and analog comparators
- Power-on reset, brown-out protection, and programmable trip conditions

C2000 controlCARD system

Unique Development Tools

We understand picking the right processor can be tough, and purchasing device-specific EVM boards can become costly. That's why we've created the controlCARD system.

The C2000 controlCARDs are the latest tools for C2000 MCUs. By detaching the C2000 processor and all necessary support devices and putting them on "controlCARDs", a designer can test multiple processors on one board. Separating the MCU from the base also decreases replacement costs should accidents happen. These controlCARDs require only one 5V supply and plug into a standard DIM socket that gives access to every pin on the device.

With over 20 experimenter and development kits available, C2000 MCUs make it easy to start developing today. All kits are complete with Code Composer Studio™ IDE v4 C28x™ Free 32KByte version and the necessary power supply. Each kit also includes documented software, example code, and full hardware documentation. Visit www.ti.com/c2000tools for more information.



controlCARD	Part Number	Description	Price
F28044	TMDSCNCD28044	F28044 controlCARD	\$59.00
F2808	TMDSCNCD2808	F2808 controlCARD	\$59.00
Piccolo™ MCUs			
F28027	TMDXCNC28027	F28027 controlCARD	\$49.00
F28035	TMDXCNC28035	F28035 controlCARD	\$59.00
F28069	TMDXCNC28069	F28069 controlCARD	\$59.00
Delfino™ MCUs			
F28335	TMDSCNCD28335	F28335 controlCARD	\$69.00
C28343	TMDXCNC28343	C28343 controlCARD	\$109.00
C28346	TMDXCNC28346-168	C283436 controlCARD	\$125.00
Concerto™ MCUs			
F28M35H52	TMDXCNC28M35H52C1	F28M35H52 controlCARD	\$99.00

Concerto Microcontroller Tools

Concerto tools will continue the C2000™ controlCARD tools methodology. By detaching the C2000 processor and all necessary support circuitry and putting them on controlCARDs, a designer can test multiple processors on one application board. These controlCARDs require only one 5-V supply and plug into a simple motherboard connector that gives access to every pin on the device. All C2000 application kits are also based on controlCARDs.

Part number	TMDXCNC28M35H52C1
Price	U.S \$130
Features	<ul style="list-style-type: none"> • F28M35H52C1 microcontroller-based controlCARD • Isolated USB JTAG interface (XDS100v2) • Micro-USB, Ethernet, and MicroSD communications interfaces • Standard 100-pin DIMM interface • Analog I/O, digital I/O, and JTAG signals at DIMM interface



H52C1 Concerto controlCARD

Part number	TMDXDOCKH52C1
Price	U.S \$185
Features	<ul style="list-style-type: none"> • F28M35H52C1 microcontroller based controlCARD • Docking station with access to all controlCARD signals • No external emulator required • Fully powered from USB connection, no external power supply needed • Code Composer Studio™ IDE v4 included • Full open-source software examples and hardware files for download in controlSUITE software

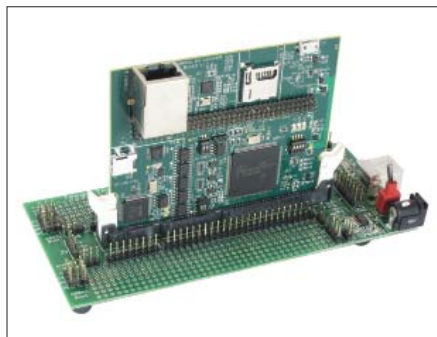

H52C1 Concerto Experimenter's Kit

Piccolo™ 32-Bit Microcontroller Tools

With the Piccolo series of TMS320F2802x/F2803x/F2806x MCUs comes low-cost USB-based tools that provide instant access to peripherals and pins. Start developing for just \$39.

Piccolo 32-Bit Microcontroller controlSTICK – \$39

- Everything you need to work with the Piccolo F28027 or F28069 microcontrollers
- Access to all Piccolo control peripherals through header pins
- On-board USB JTAG emulation (no external emulator required)
- Numerous sample labs to get you started immediately



Part Number	MCU	Features	Price
TMDS28027USB	60-MHz F28027 MCU	9-ch PWM, 13-ch ADC, 9 timers	\$39
TMDX28069USB	80-MHz F28069 floating-point MCU	19-ch PWM, 16-ch ADC, 16 timers, CLA, VCU	\$39

Experimenter's Kits – Starting at \$79

- Launch Piccolo MCU-based designs quickly and easily
- Access to all Piccolo functional device pins
- Prototyping area to get started developing quickly and easily
- On-board USB JTAG emulation (no external emulator required)
- Compatible with controlSTICK example projects

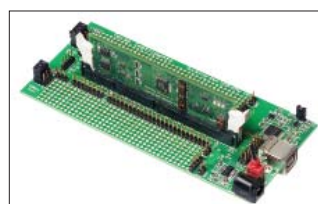

Part Number	MCU	Features	Price
TMDSDOCK28027	60-MHz F28027 MCU	9-ch PWM, 13-ch ADC, 9 timers	\$79
TMDSDOCK28035	60-MHz F28035 MCU	15-ch PWM, 16-ch ADC, 12 timers, CLA	\$89
TMDXDOCK28069	80-MHz F28069 floating-point MCU	19-ch PWM, 16-ch ADC, 16 timers, CLA, VCU	\$99

Delfino™ Microcontroller Tools

Delfino brings C2000 MCUs to a whole new level. Experiment with the high-performance, floating-point microcontrollers offered in the Delfino series. Evaluate the functionality and performance with easy-to-use development tools.

Experimenter's Kits for RAM-based C2834x MCUs – Starting at \$159

Key Features	DIM168	DIM100
C28x™ device	300-MHz C28346	200-MHz C28343
ADC channels accessible	16 channels	12 channels
On-board ADC	No	2×12-bit, 12-channel (2 MSPS)
External memory I/F accessible	Yes	No
External memory	2×128 kB SRAM; 64 kB EEPROM	64 kB EEPROM
Accessible I/O pins	All	Control peripherals
Power supply	Single 5V	Single 5V
Pricing	\$189	\$159
Part number	TMDSDOCK28346-168	TMDSDOCK28343



Delfino Experimenter's Kit

Experimenter's Kit for Flash-based F2833x MCUs – \$99

- Access to all controlCARD signals
- Breadboard area
- On-board USB JTAG emulation
- Example projects to get experimenting quickly

Key Features	DIM100
C28x™ device	150-MHz F28335
Flash memory	512 KB
ADC channels accessible	16 channels
On-board ADC	12-bit, 16-channel (12.5 MSPS)
External memory I/F accessible	No
Accessible I/O pins	Control peripherals
Power supply	Single 5V
Pricing	\$99
Part number	TMDS28335DOCK

Peripheral Explorer Kit – \$179

- F28335 ControlCARD
- Baseboard onboard XDS100 USB JTAG emulation and inputs to the majority of C2000 peripherals including: GPIO pins, ADC, ePWM, eCAP, I²C, and McBSP
- Included C2000 teaching ROM provides classroom-level instruction
- Schematics and Gerber files available through controlSUITE™ software
- Code Composer Studio™ IDE V4 with 32KB code size limit

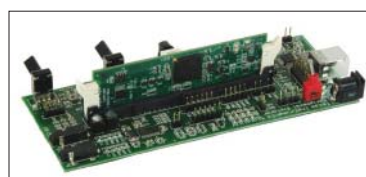

Third-Party JTAG Emulators

Name	Device	Website	Description	Price
JTAG Emulators				
Blackhawk USB2000	All C2000	www.blackhawk-dsp.com	Blackhawk USB2000 USB JTAG Emulator	\$299.00
XDS510LC	All C2000	www.spectrumdigital.com	Spectrum Digital XDS510LC USB JTAG Emulator	\$249.00
XDS510USB	All C2000	www.spectrumdigital.com	XDS510™ USB Emulator, works with multiple TI families	\$1,299.00
JTAGjet-C2000	All C2000	www.signum.com	XDS510 class USB emulator. C2000 only.	\$595.00
JTAGjet-C2000-ISO	All C2000	www.signum.com	XDS510 class USB 2.0 emulator with optically isolated JTAG. C2000 only.	\$795.00

Industry-Leading Development Environment

The Code Composer Studio™ integrated development environment (IDE) delivers all of the host tools and runtime software support for your C2000 microcontroller-based real-time embedded applications. The Code Composer Studio (CCStudio) IDE allows developers of all experience levels to move quickly through each phase of the application development process including designing, coding and building, debugging, analyzing, and tuning. Powerful tools and interfaces allow users to get started faster and become productive immediately. All development tools come with a size-limited version of CCStudio IDE. Free versions of CCStudio IDE v4 include code-limited MCU edition and XDS100-limited edition. Full MCU edition available from \$445.

Code Composer Studio IDE

- Project manager
- File associations
- Source, libraries, and files included
- C2000 supports both CCStudio IDE v3.3 and CCStudio IDE v4

Full C/C++ and Assembly Debugging

- C and ASM source
- Mixed mode
- Set break and probe points

C2000 MCU Real-Time Debugging

- Graph and modify variables/registers in real time while running code
- Allows you to halt in non-critical code for debugging while time-critical interrupts continue to be serviced
- Access memory and registers without stopping the processor
- Implemented in silicon, not by a debugging monitor: easy to use, no application resources required

Key Benefits

- DSP/BIOS™ kernel scheduler
- Real-time analysis capabilities
- Visual project manager
- Debugger and optimization tools
- Flash programming plug-in
- C/C++ compiler, assembler, linker
- Real-time watch windows and graphs
- Register name auto completion

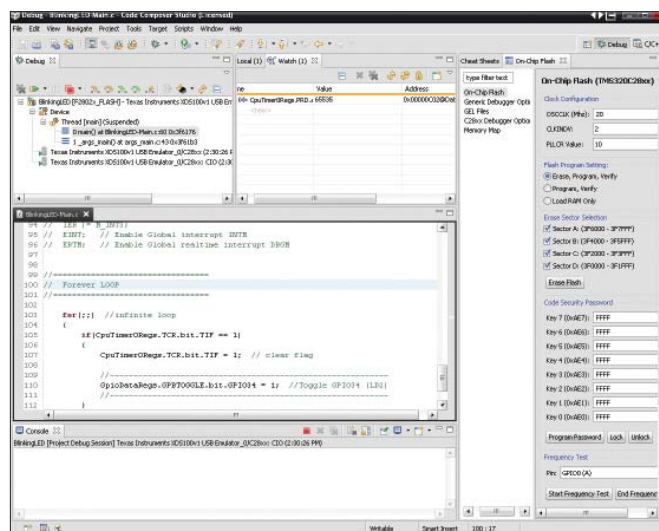

Software and Support

controlSUITE™ software for C2000 microcontrollers is your one-stop resource for C2000 software and information. It provides a cohesive set of software infrastructure and software tools designed to minimize software development time. From device-specific drivers and support software to complete system examples and technical training, controlSUITE software provides libraries, examples, and support at every stage of development and evaluation. Go beyond simple code snippets – jump start your real-time system with real-world software.

controlSUITE Interface

controlSUITE software provides a graphical user interface for intuitive navigation of software, development kits, libraries, user guides, applications notes, and more.

- Access device software, kit software, and libraries
- Launch example projects into Code Composer Studio™ IDE v4 directly from controlSUITE software
- Find relevant and useful documentation for your design
- Know about the latest training available
- Stay up to date with the latest C2000 software and development kit releases

controlSUITE Software

- Meticulously documented example projects guiding you from device operation up to complete, end-application examples
- Powerful device libraries for math, DSP, and utility functions
- Real-world application libraries for areas such as digital power and digital motor control
- Completely free hardware developer's packages, including BOMs, layout, schematics, and gerbers
- Informative user's guides and application notes to get you started quickly and developing sooner

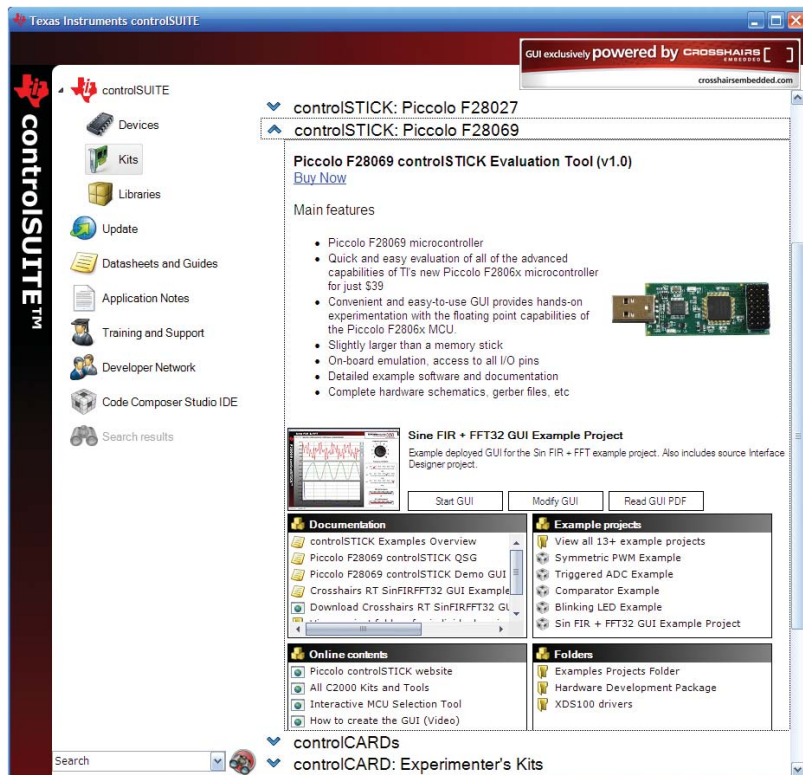
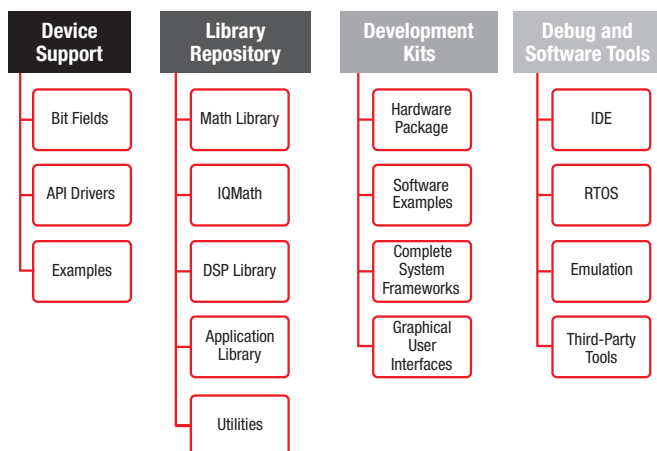

controlSUITE Software Benefits

One stop for all C2000 software

- Single, centralized location
- Intelligent installer eliminates the search for dependencies
- Notifications for software updates
- controlSUITE Graphical Interface helps to navigate all C2000 resources

Open, real-world systems

- Compilation of 15 years of systems and applications expertise
- Unique, optimized libraries for math, filtering, DSP and specific applications with complete system examples utilizing incremental builds
- Allows developers to focus on differentiation, not basics

Program the MCU your way

- Significantly reduces development time with hardware abstraction and extensive libraries
- Four inter-usable levels of hardware abstraction

Best of all, controlSUITE software is completely FREE!
Download today at www.ti.com/controlsuite

Training

TI provides a multitude of training opportunities for C2000 microcontrollers. Between hands-on multi-day and single-day workshops, webcasts, and online training, it's easy to gain a working understanding of how to optimally use the C28x™ microcontroller and accelerate product development. For a full list of training opportunities, visit www.ti.com/c2000training

Tech Days

Join Texas Instruments for a day packed with technical design sessions and technology exhibits. These rotating seminars are aimed at providing a learning forum where practical high-performance design solutions, tools, techniques, topologies, and examples will be presented. The exhibits will demonstrate the latest TI technology so don't miss this opportunity to meet with a number of Texas Instruments' experts and gain valuable ideas for solving your technical challenges. Check the schedule at www.ti.com/techdays

Third-Party Tools and Software

The MathWorks® Embedded

Target for C2000 Microcontrollers

Embedded Target integrates MATLAB® and Simulink® with TI's Code Composer Studio™ IDE and C2000 microcontrollers. Together, these products let you perform automatic code generation, prototyping, and embedded system deployment. With Embedded Target, you can develop and validate control designs and DSP algorithms from concept through code.

www.mathworks.com/products/tic2000

VisSim/Embedded Controls Developer™

VisSim/Embedded Controls Developer is a visual development environment for the rapid prototyping and development of motion-control systems. VisSim is unique in its ability to generate small memory footprint target files and can drastically reduce development time and lower prototyping costs. www.vissim.com/c2000

Key Features

- Generates documented, readable, and editable C code in Code Composer Studio IDE project format
- Automates the testing and execution of Simulink models
- Enables the real-time evaluation of system designs on eZdsp™ boards
- Provides block-level access to on-chip peripherals
- Provides block-level access to the TI IQMath library for simulation and code generation

Key Features

- VisSim/Motion per vissim.com block set that includes pre-built motor, amplifier, sensor, encoder, dynamic load, and PID models
- C2000 MCU DMC block set includes all of the TI DMC library in block form
- Peripheral blocks generate code for C2000 MCU on-chip devices
- Automatic C code generation of production-quality fixed-point code
- Real-time visualization while code executes on DSPs
- Code Composer Studio IDE plug-in for automatic project creation

Third Party	Website	Service
C2000 Microcontroller Third Parties		
D3 Engineering	www.d3engineering.com	Design Services; Consulting; Algorithms
Drivetech	www.drivetechinc.com	Design Services; Consulting; DMC Expertise
The MathWorks	www.mathworks.com	Embedded Target; Auto Code Generation
Visual Solutions	www.vissim.com	Rapid Prototyper; Visual Application Development
Signum Systems	www.signum.com	Tools: Flash Programming; Emulation
Windmill	www.windmill-systems.com	TCP/IP
Pentad Design	www.pentaddesign.com	Design Services, DPS and CLA Expertise

Selected Package Options for TMS320C2000™ Devices

38-pin DA (TSSOP)

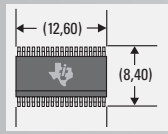

48-pin PT

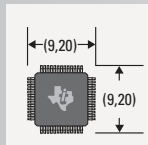

64-pin TQFP

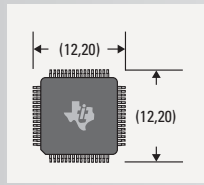

80-pin PN (LQFP)

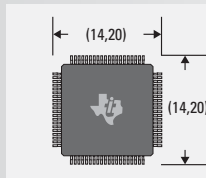

100-pin PQFP

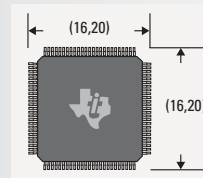

128-pin PQFP

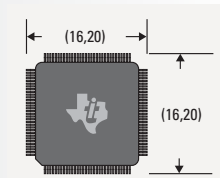

144-pin PQFP

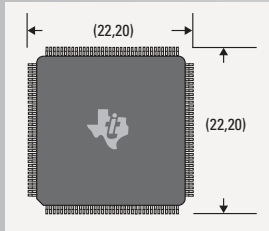

176-pin LQFP

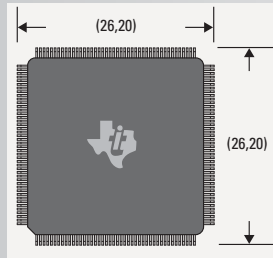

100-pin BGA

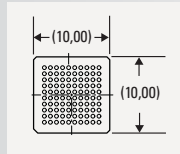

179-pin BGA

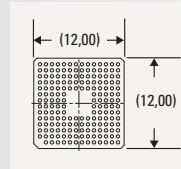

256-pin BGA

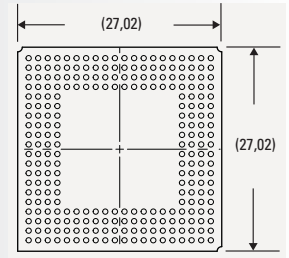

TI Worldwide Technical Support

Internet

TI Semiconductor Product Information Center Home Page
support.ti.com

TI E2E™ Community Home Page
e2e.ti.com

Product Information Centers

Americas	Phone	+1(972) 644-5580
Brazil	Phone	0800-891-2616
Mexico	Phone	0800-670-7544
	Fax	+1(972) 927-6377
	Internet/Email	support.ti.com/sc/pic/americas.htm

Europe, Middle East, and Africa

Phone		
European Free Call	00800-ASK-TEXAS (00800 275 83927)	
International	+49 (0) 8161 80 2121	
Russian Support	+7 (4) 95 98 10 701	
Note: The European Free Call (Toll Free) number is not active in all countries. If you have technical difficulty calling the free call number, please use the international number above.		
Fax	+ (49) (0) 8161 80 2045	
Internet	support.ti.com/sc/pic/euro.htm	
Direct Email	asktexas@ti.com	

Japan

Phone	Domestic	0120-92-3326
Fax	International	+81-3-3344-5317
	Domestic	0120-81-0036
Internet/Email	International	support.ti.com/sc/pic/japan.htm
	Domestic	www.tij.co.jp/pic

Asia

Phone		
International	+91-80-41381665	
Domestic	Toll-Free Number	
Note: Toll-free numbers do not support mobile and IP phones.		
Australia	1-800-999-084	
China	800-820-8682	
Hong Kong	800-96-5941	
India	1-800-425-7888	
Indonesia	001-803-8861-1006	
Korea	080-551-2804	
Malaysia	1-800-80-3973	
New Zealand	0800-446-934	
Philippines	1-800-765-7404	
Singapore	800-886-1028	
Taiwan	0800-006800	
Thailand	001-800-886-0010	
Fax	+8621-23073686	
Email	tiasia@ti.com or ti-china@ti.com	
Internet	support.ti.com/sc/pic/asia.htm	

Important Notice: The products and services of Texas Instruments Incorporated and its subsidiaries described herein are sold subject to TI's standard terms and conditions of sale. Customers are advised to obtain the most current and complete information about TI products and services before placing orders. TI assumes no liability for applications assistance, customer's applications or product designs, software performance, or infringement of patents. The publication of information regarding any other company's products or services does not constitute TI's approval, warranty or endorsement thereof.

B122010

The platform bar, C2000, C28x, Code Composer Studio, Concerto, controlSUITE, Delfino, DSP/BIOS, E2E, Piccolo, TMS320C2000, TMS320C28x and XDS510 are trademarks of Texas Instruments.

All other trademarks are the property of their respective owners.

IMPORTANT NOTICE

Texas Instruments Incorporated and its subsidiaries (TI) reserve the right to make corrections, modifications, enhancements, improvements, and other changes to its products and services at any time and to discontinue any product or service without notice. Customers should obtain the latest relevant information before placing orders and should verify that such information is current and complete. All products are sold subject to TI's terms and conditions of sale supplied at the time of order acknowledgment.

TI warrants performance of its hardware products to the specifications applicable at the time of sale in accordance with TI's standard warranty. Testing and other quality control techniques are used to the extent TI deems necessary to support this warranty. Except where mandated by government requirements, testing of all parameters of each product is not necessarily performed.

TI assumes no liability for applications assistance or customer product design. Customers are responsible for their products and applications using TI components. To minimize the risks associated with customer products and applications, customers should provide adequate design and operating safeguards.

TI does not warrant or represent that any license, either express or implied, is granted under any TI patent right, copyright, mask work right, or other TI intellectual property right relating to any combination, machine, or process in which TI products or services are used. Information published by TI regarding third-party products or services does not constitute a license from TI to use such products or services or a warranty or endorsement thereof. Use of such information may require a license from a third party under the patents or other intellectual property of the third party, or a license from TI under the patents or other intellectual property of TI.

Reproduction of TI information in TI data books or data sheets is permissible only if reproduction is without alteration and is accompanied by all associated warranties, conditions, limitations, and notices. Reproduction of this information with alteration is an unfair and deceptive business practice. TI is not responsible or liable for such altered documentation. Information of third parties may be subject to additional restrictions.

Resale of TI products or services with statements different from or beyond the parameters stated by TI for that product or service voids all express and any implied warranties for the associated TI product or service and is an unfair and deceptive business practice. TI is not responsible or liable for any such statements.

TI products are not authorized for use in safety-critical applications (such as life support) where a failure of the TI product would reasonably be expected to cause severe personal injury or death, unless officers of the parties have executed an agreement specifically governing such use. Buyers represent that they have all necessary expertise in the safety and regulatory ramifications of their applications, and acknowledge and agree that they are solely responsible for all legal, regulatory and safety-related requirements concerning their products and any use of TI products in such safety-critical applications, notwithstanding any applications-related information or support that may be provided by TI. Further, Buyers must fully indemnify TI and its representatives against any damages arising out of the use of TI products in such safety-critical applications.

TI products are neither designed nor intended for use in military/aerospace applications or environments unless the TI products are specifically designated by TI as military-grade or "enhanced plastic." Only products designated by TI as military-grade meet military specifications. Buyers acknowledge and agree that any such use of TI products which TI has not designated as military-grade is solely at the Buyer's risk, and that they are solely responsible for compliance with all legal and regulatory requirements in connection with such use.

TI products are neither designed nor intended for use in automotive applications or environments unless the specific TI products are designated by TI as compliant with ISO/TS 16949 requirements. Buyers acknowledge and agree that, if they use any non-designated products in automotive applications, TI will not be responsible for any failure to meet such requirements.

Following are URLs where you can obtain information on other Texas Instruments products and application solutions:

Products

Audio	www.ti.com/audio
Amplifiers	amplifier.ti.com
Data Converters	dataconverter.ti.com
DLP® Products	www.dlp.com
DSP	dsp.ti.com
Clocks and Timers	www.ti.com/clocks
Interface	interface.ti.com
Logic	logic.ti.com
Power Mgmt	power.ti.com
Microcontrollers	microcontroller.ti.com
RFID	www.ti-rfid.com
OMAP Mobile Processors	www.ti.com/omap
Wireless Connectivity	www.ti.com/wirelessconnectivity

Applications

Communications and Telecom	www.ti.com/communications
Computers and Peripherals	www.ti.com/computers
Consumer Electronics	www.ti.com/consumer-apps
Energy and Lighting	www.ti.com/energy
Industrial	www.ti.com/industrial
Medical	www.ti.com/medical
Security	www.ti.com/security
Space, Avionics and Defense	www.ti.com/space-avionics-defense
Transportation and Automotive	www.ti.com/automotive
Video and Imaging	www.ti.com/video

TI E2E Community Home Page

e2e.ti.com

Mailing Address: Texas Instruments, Post Office Box 655303, Dallas, Texas 75265
Copyright © 2011, Texas Instruments Incorporated