

OP27A, OP27C

LOW-NOISE HIGH-SPEED PRECISION OPERATIONAL AMPLIFIERS

SLOS100E – FEBRUARY 1989 – REVISED FEBRUARY 2010

- Replacements for ADI, PMI and LTC OP27 Series

Features of OP27A and OP27C:

- **Maximum Equivalent Input Noise Voltage:**
 3.8 nV/√Hz at 1 kHz
 5.5 nV/√Hz at 10 kHz
- **Very Low Peak-to-Peak Noise Voltage at 0.1 Hz to 10 Hz . . . 80 nV Typ**
- **Low Input Offset Voltage**
 OP27A . . . 25 μV Max
 OP27C . . . 100 μV Max
- **High Voltage Amplification**
 OP27A . . . 1 V/μV Min
 OP27C . . . 0.7 V/μV Min

description

The OP27 operational amplifiers combine outstanding noise performance with excellent precision and high-speed specifications. The wideband noise is only 3 nV/√Hz and with the 1/f noise corner at 2.7 Hz, low noise is maintained for all low-frequency applications.

The outstanding characteristics of the OP27 make these devices excellent choices for low-noise amplifier applications requiring precision performance and reliability.

The OP27 series is compensated for unity gain.

The OP27A and OP27C are characterized for operation over the full military temperature range of –55°C to 125°C.

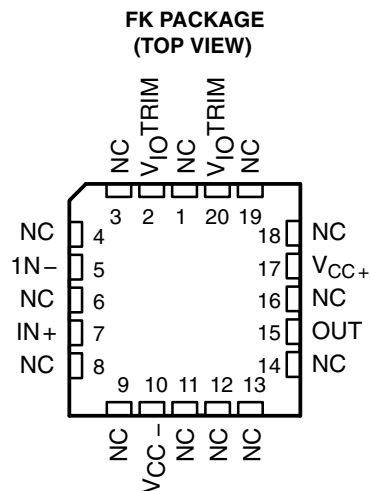
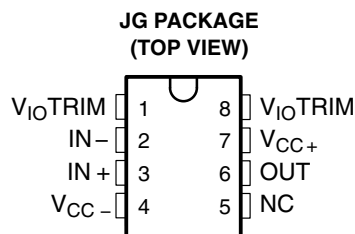

NC – No internal connection

symbol

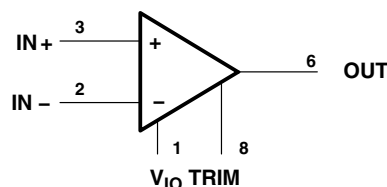

Pin numbers are for the JG packages.

AVAILABLE OPTIONS

T _A	V _{IO} max AT 25°C	STABLE GAIN	PACKAGE	
			CERAMIC DIP (JG)	CHIP CARRIER (FK)
–55°C to 125°C	25 μV	1	OP27AJG	OP27AFK
	100 μV	1	OP27CJG	—



Please be aware that an important notice concerning availability, standard warranty, and use in critical applications of Texas Instruments semiconductor products and disclaimers thereto appears at the end of this data sheet.

PRODUCTION DATA information is current as of publication date. Products conform to specifications per the terms of Texas Instruments standard warranty. Production processing does not necessarily include testing of all parameters.

**TEXAS
INSTRUMENTS**

POST OFFICE BOX 655303 • DALLAS, TEXAS 75265

Copyright © 2010, Texas Instruments Incorporated

OP27A, OP27C LOW-NOISE HIGH-SPEED PRECISION OPERATIONAL-AMPLIFIER

SLOS100E - FEBRUARY 1989 - REVISED FEBRUARY 2010

schematic

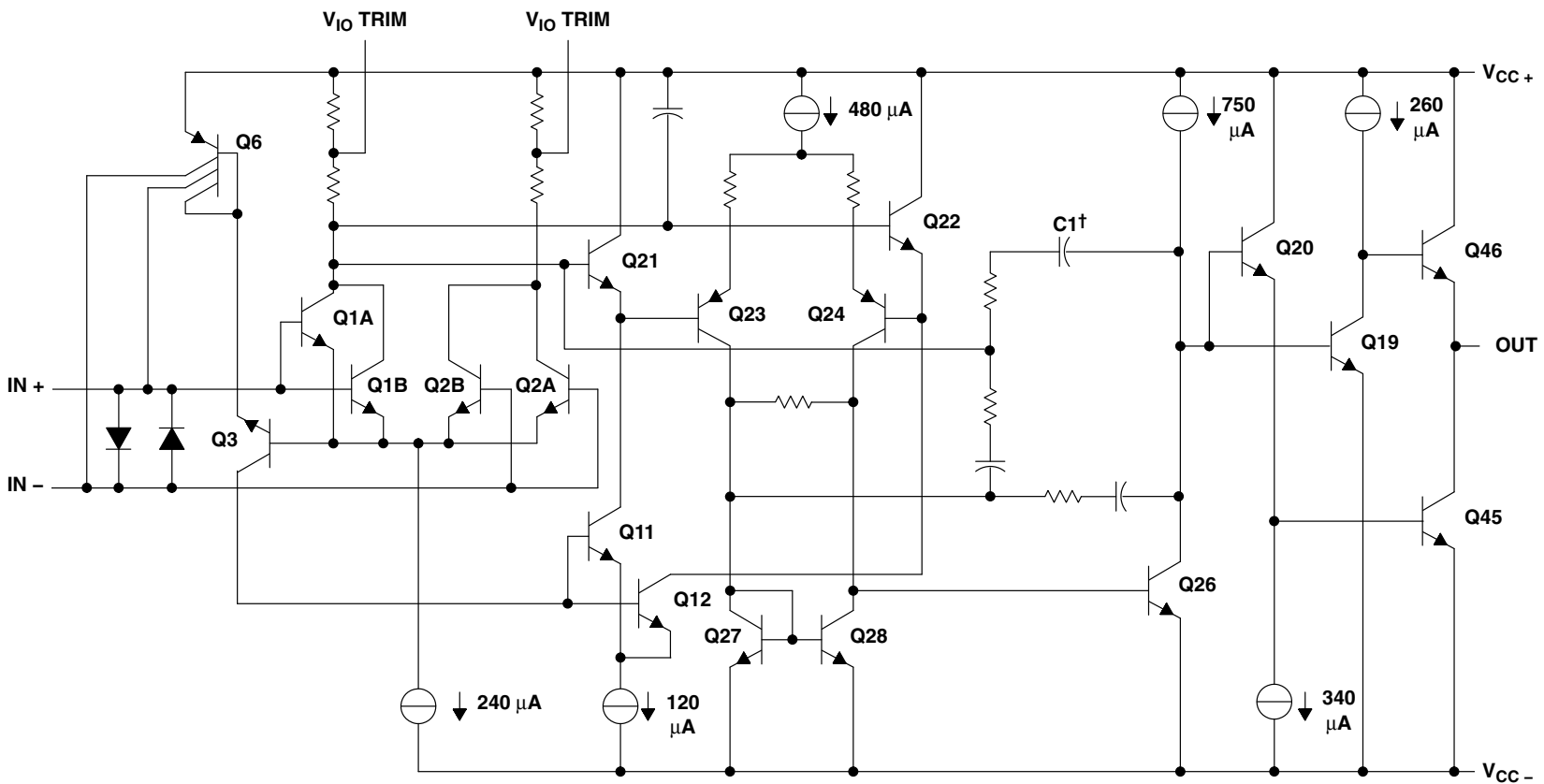

† C1 = 120 pF for OP27

OP27A, OP27C

LOW-NOISE HIGH-SPEED PRECISION OPERATIONAL-AMPLIFIER

SLOS100E – FEBRUARY 1989 – REVISED FEBRUARY 2010

absolute maximum ratings over operating free-air temperature range (unless otherwise noted)

Supply voltage, V_{CC+} (see Note 1)	22 V
Supply voltage, V_{CC-} (see Note 1)	22 V
Input voltage, V_I	$V_{CC\pm}$
Duration of output short circuit	unlimited
Differential input current (see Note 2)	± 25 mA
Continuous power dissipation	See Dissipation Rating Table
Operating free-air temperature range: OP27A, OP27C	-55°C to 125°C
Storage temperature range	-65°C to 150°C
Lead temperature 1,6 mm (1/16 inch) from case for 60 seconds: JG or FK package	300°C

- NOTES: 1. All voltage values are with respect to the midpoint between V_{CC+} and V_{CC-} unless otherwise noted.
 2. The inputs are protected by back-to-back diodes. Current-limiting resistors are not used in order to achieve low noise. Excessive input current will flow if a differential input voltage in excess of approximately ± 0.7 V is applied between the inputs unless some limiting resistance is used.

DISSIPATION RATING TABLE

PACKAGE	$T_A \leq 25^{\circ}\text{C}$ POWER RATING	DERATING FACTOR ABOVE $T_A = 25^{\circ}\text{C}$	$T_A = 85^{\circ}\text{C}$ POWER RATING	$T_A = 125^{\circ}\text{C}$ POWER RATING
JG	1050 mW	8.4 mW/ $^{\circ}\text{C}$	546 mW	210 mW
FK	1375 mW	11.0 mW/ $^{\circ}\text{C}$	715 mW	275 mW



OP27A, OP27C LOW-NOISE HIGH-SPEED PRECISION OPERATIONAL-AMPLIFIER

SLOS100E – FEBRUARY 1989 – REVISED FEBRUARY 2010

recommended operating conditions

		OP27A			OP27C			UNIT
		MIN	NOM	MAX	MIN	NOM	MAX	
Supply voltage, V_{CC+}		4	15	22	4	15	22	V
Supply voltage, V_{CC-}		-4	-15	-22	-4	-15	-22	V
Common-mode input voltage, V_{IC}	$V_{CC\pm} = \pm 15\text{ V}$, $T_A = 25^\circ\text{C}$	± 11			± 11			V
	$V_{CC\pm} = \pm 15\text{ V}$, $T_A = -55^\circ\text{C}$ to 125°C	± 10.3			± 10.2			
Operating free-air temperature, T_A		-55		125	-55		125	$^\circ\text{C}$

electrical characteristics at specified free-air temperature, $V_{CC\pm} = \pm 15\text{ V}$ (unless otherwise noted)

PARAMETER		TEST CONDITIONS	T_A^\dagger	OP27A			OP27C			UNIT
				MIN	TYP	MAX	MIN	TYP	MAX	
V_{IO}	Input offset voltage	$V_O = 0$, $R_S = 50\ \Omega$, $V_{IC} = 0$ See Note 3	25 $^\circ\text{C}$	10		25	30		100	μV
			Full range	60			300			
α_{VIO}	Average temperature coefficient of input offset voltage		Full range	0.2	0.6	0.4		1.8	$\mu\text{V}/^\circ\text{C}$	
	Long-term drift of input offset voltage	See Note 4		0.2	1	0.4		2	$\mu\text{V}/\text{mo}$	
I_{IO}	Input offset current	$V_O = 0$, $V_{IC} = 0$	25 $^\circ\text{C}$	7	35	12		75	nA	
			Full range	50			135			
I_{IB}	Input bias current	$V_O = 0$, $V_{IC} = 0$	25 $^\circ\text{C}$	± 10	± 40	± 15		± 80	nA	
			Full range	± 60			± 150			
V_{ICR}	Common-mode input voltage range		25 $^\circ\text{C}$	11 to -11	11 to -11				V	
			Full range	10.3 to -10.3	10.5 to -10.5					
V_{OM}	Peak output voltage swing	$R_L \geq 2\ \text{k}\Omega$		± 12		± 13.8		± 11.5		V
				± 10		± 11.5		± 10		
			Full range	± 11.5			10.5			
A_{VD}	Large-signal differential voltage amplification	$R_L \geq 2\ \text{k}\Omega$, $V_O = \pm 10\ \text{V}$		1000	1800	700		1500	V/mV	
				800	1500	1500				
			$R_L \geq 0.6\ \text{k}\Omega$, $V_O = \pm 1\ \text{V}$, $V_{CC\pm} = \pm 4\ \text{V}$	250	700	200		500		
		Full range	600			300				
$r_{i(CM)}$	Common-mode input resistance			3			2		G Ω	
r_o	Output resistance	$V_O = 0$, $I_O = 0$	25 $^\circ\text{C}$	70			70		Ω	
CMRR	Common-mode rejection ratio	$V_{IC} = \pm 11\ \text{V}$	25 $^\circ\text{C}$	114	126	100		120	dB	
			Full range	110			94			
k_{SVR}	Supply voltage rejection ratio	$V_{CC\pm} = \pm 4\ \text{V}$ to $\pm 18\ \text{V}$	25 $^\circ\text{C}$	100	120	94		118	dB	
			Full range	96			86			

† Full range is -55°C to 125°C .

- NOTES: 3. Input offset voltage measurements are performed by automatic test equipment approximately 0.5 seconds after applying power.
4. Long-term drift of input offset voltage refers to the average trend line of offset voltage versus time over extended periods after the first 30 days of operation. Excluding the initial hour of operation, changes in V_{IO} during the first 30 days are typically 2.5 μV (see Figure 3).



OP27A, OP27C

LOW-NOISE HIGH-SPEED PRECISION OPERATIONAL-AMPLIFIER

SLOS100E – FEBRUARY 1989 – REVISED FEBRUARY 2010

OP27 operating characteristics, $V_{CC\pm} = \pm 15\text{ V}$, $T_A = 25^\circ\text{C}$

PARAMETER		TEST CONDITIONS	OP27A			OP27C			UNIT	
			MIN	TYP	MAX	MIN	TYP	MAX		
SR	Slew rate	$A_{VD} \geq 1$, $R_L \geq 2\text{ k}\Omega$	1.7	2.8		1.7	2.8		$\text{V}/\mu\text{s}$	
$V_{N(PP)}$	Peak-to-peak equivalent input noise voltage	$f = 0.1\text{ Hz to }10\text{ Hz}$, $R_S = 20\ \Omega$, See Figure 26		0.225	0.375		0.225	0.375		μV
V_n	Equivalent input noise voltage	$f = 10\text{ Hz}$, $R_S = 20\ \Omega$		3.5	8		3.8	8	$\text{nV}/\sqrt{\text{Hz}}$	
		$f = 1\text{ kHz}$, $R_S = 20\ \Omega$		3	4		3.2	4		
I_n	Equivalent input noise current	$f = 10\text{ Hz}$, See Figure 27		5	25		5	25	$\text{pA}/\sqrt{\text{Hz}}$	
		$f = 1\text{ kHz}$, See Figure 27		0.7	2.5		0.7	2.5		
	Gain-bandwidth product	$f = 100\text{ kHz}$	5	8		5	8		MHz	



OP27A, OP27C LOW-NOISE HIGH-SPEED PRECISION OPERATIONAL-AMPLIFIER

SLOS100E – FEBRUARY 1989 – REVISED FEBRUARY 2010

TYPICAL CHARACTERISTICS

Table of Graphs

		FIGURE	
V_{IO}	Input offset voltage	vs Temperature	1
ΔV_{IO}	Change in input offset voltage	vs Time after power on	2
		vs Time (long-term drift)	3
I_{IO}	Input offset current	vs Temperature	4
I_{IB}	Input bias current	vs Temperature	5
V_{ICR}	Common-mode input voltage range	vs Supply voltage	6
V_{OM}	Maximum peak output voltage	vs Load resistance	7
$V_{O(PP)}$	Maximum peak-to-peak output voltage	vs Frequency	8
A_{VD}	Differential voltage amplification	vs Supply voltage	9
		vs Load resistance	10
		vs Frequency	11, 12
CMRR	Common-mode rejection ratio	vs Frequency	13
k_{SVR}	Supply voltage rejection ratio	vs Frequency	14
SR	Slew rate	vs Temperature	15
ϕ_m	Phase margin	vs Temperature	16
ϕ	Phase shift	vs Frequency	11
V_n	Equivalent input noise voltage	vs Bandwidth	17
		vs Source resistance	18
		vs Supply voltage	19
		vs Temperature	20
		vs Frequency	21
	Gain-bandwidth product	vs Temperature	16
I_{OS}	Short-circuit output current	vs Time	22
I_{CC}	Supply current	vs Supply voltage	23
	Pulse response	Small signal	24
		Large signal	25



TYPICAL CHARACTERISTICS

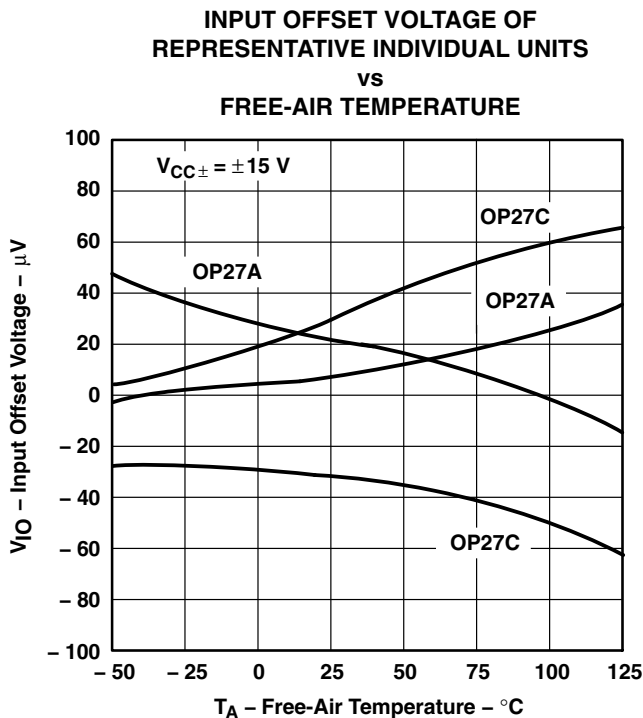

Figure 1

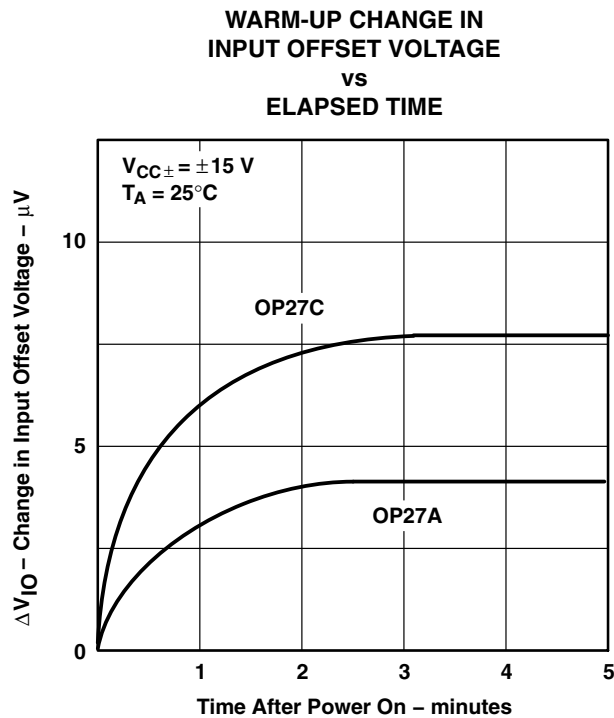

Figure 2

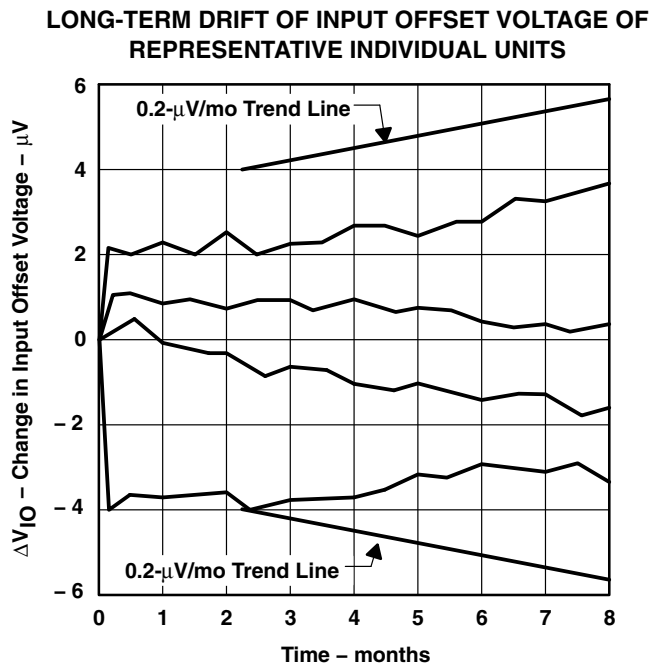

Figure 3

OP27A, OP27C LOW-NOISE HIGH-SPEED PRECISION OPERATIONAL-AMPLIFIER

SLOS100E – FEBRUARY 1989 – REVISED FEBRUARY 2010

TYPICAL CHARACTERISTICS

**INPUT OFFSET CURRENT
vs
FREE-AIR TEMPERATURE**

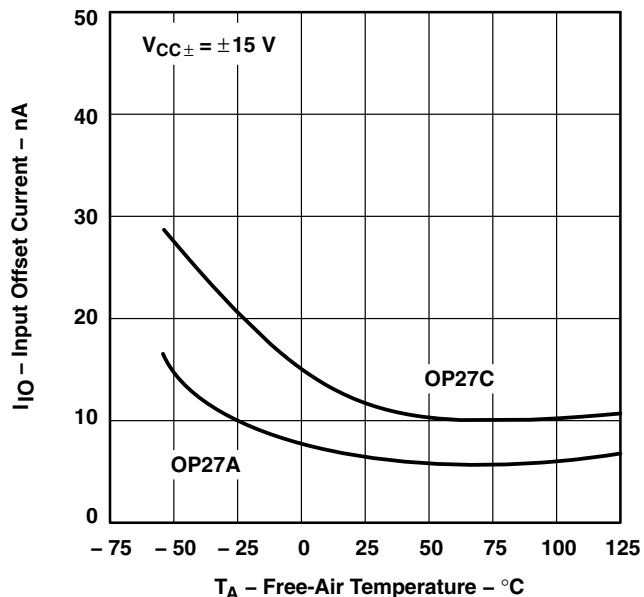

Figure 4

**INPUT BIAS CURRENT
vs
FREE-AIR TEMPERATURE**

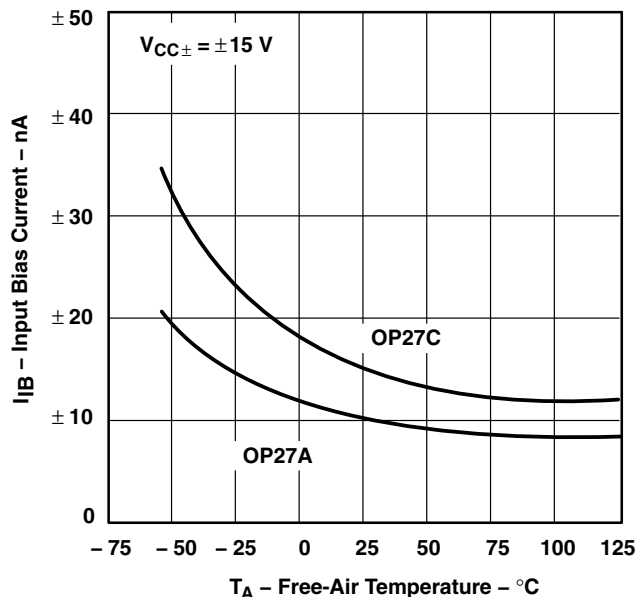

Figure 5

**COMMON-MODE INPUT VOLTAGE RANGE LIMITS
vs
SUPPLY VOLTAGE**

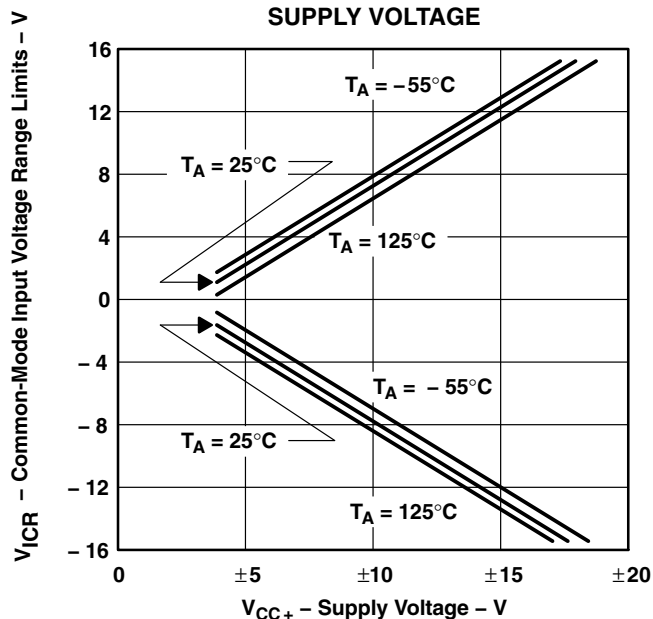

Figure 6

**MAXIMUM PEAK OUTPUT VOLTAGE
vs
LOAD RESISTANCE**

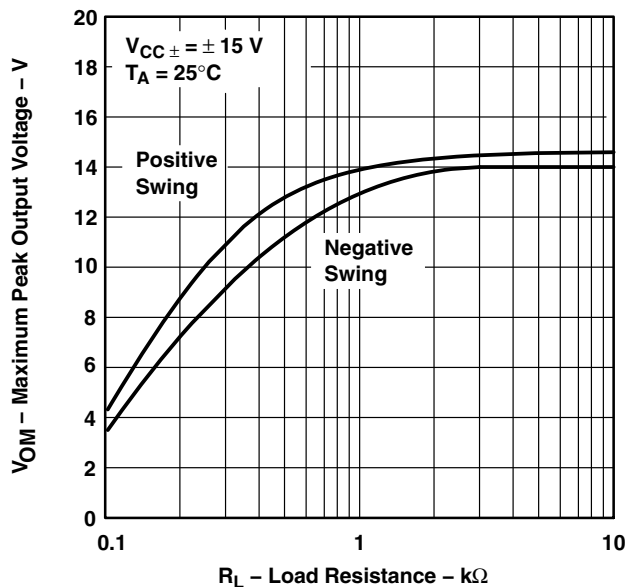

Figure 7



TYPICAL CHARACTERISTICS

OP27
MAXIMUM PEAK-TO-PEAK
OUTPUT VOLTAGE
vs
FREQUENCY

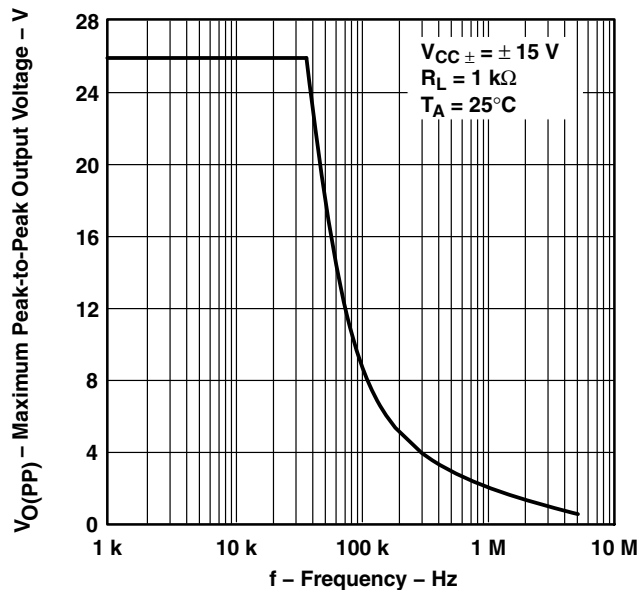

Figure 8.

OP27A
LARGE-SIGNAL
DIFFERENTIAL VOLTAGE AMPLIFICATION
vs
TOTAL SUPPLY VOLTAGE

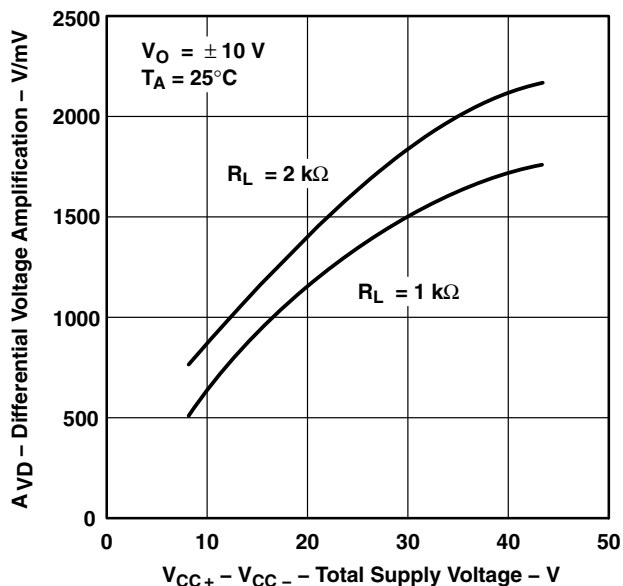

Figure 9

OP27A
LARGE-SIGNAL
DIFFERENTIAL VOLTAGE AMPLIFICATION
vs
LOAD RESISTANCE

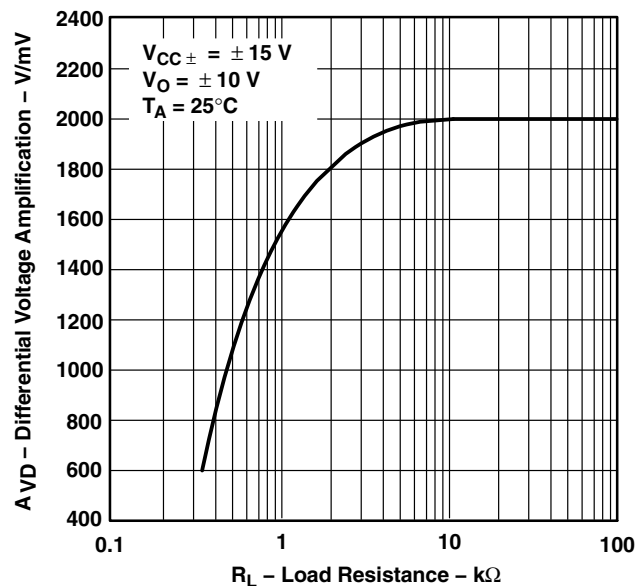

Figure 10

OP27A, OP27C LOW-NOISE HIGH-SPEED PRECISION OPERATIONAL-AMPLIFIER

SLOS100E – FEBRUARY 1989 – REVISED FEBRUARY 2010

TYPICAL CHARACTERISTICS

OP27
LARGE-SIGNAL DIFFERENTIAL
VOLTAGE AMPLIFICATION AND PHASE SHIFT
vs
FREQUENCY

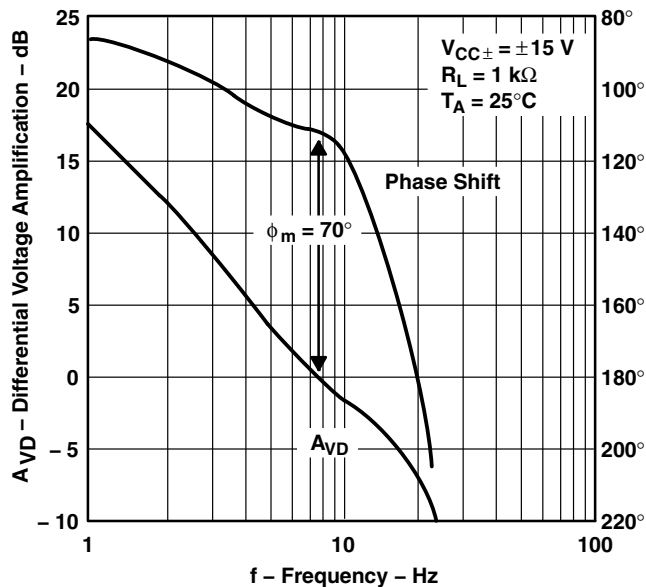

Figure 11.

OP27A
LARGE-SIGNAL
DIFFERENTIAL VOLTAGE AMPLIFICATION
vs
FREQUENCY

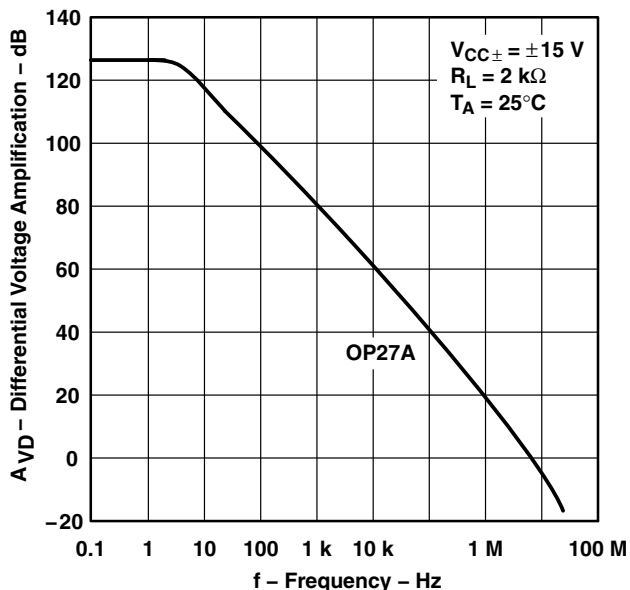

Figure 12

OP27A
COMMON-MODE REJECTION RATIO
vs
FREQUENCY

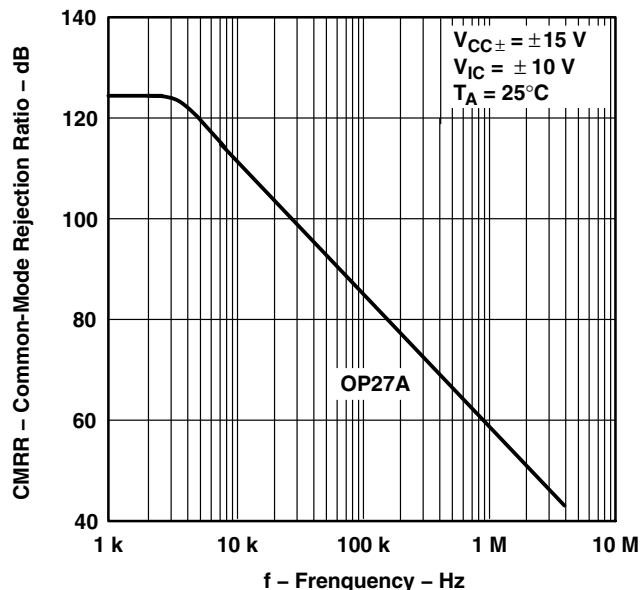

Figure 13



TYPICAL CHARACTERISTICS

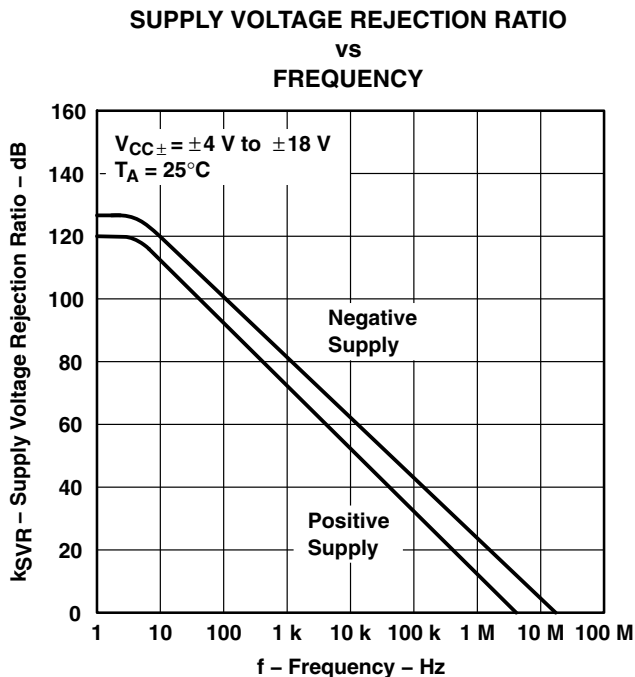

Figure 14

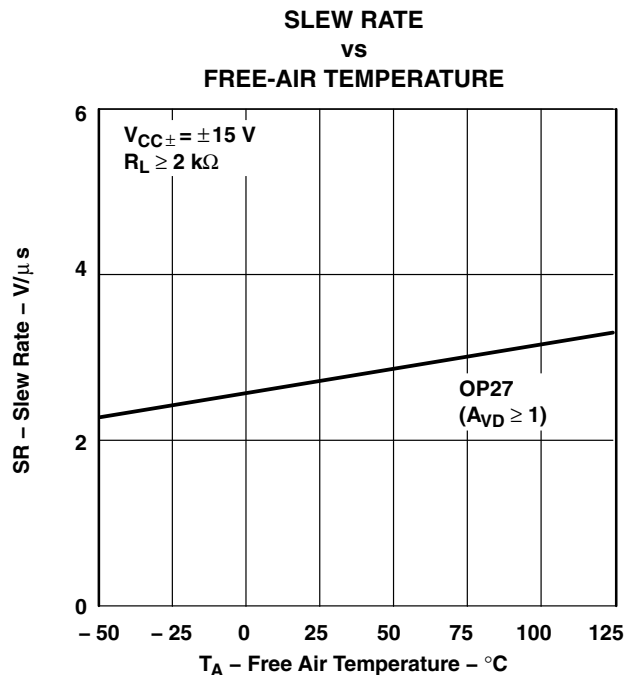

Figure 15

**OP27
PHASE MARGIN AND
GAIN-BANDWIDTH PRODUCT
vs
FREE-AIR TEMPERATURE**

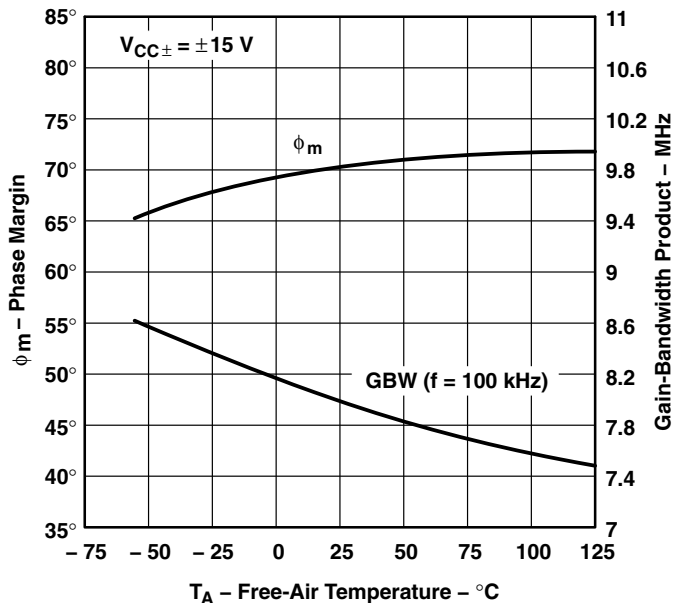

Figure 16.

OP27A, OP27C LOW-NOISE HIGH-SPEED PRECISION OPERATIONAL-AMPLIFIER

SLOS100E – FEBRUARY 1989 – REVISED FEBRUARY 2010

TYPICAL CHARACTERISTICS

**EQUIVALENT INPUT NOISE VOLTAGE
vs
BANDWIDTH**

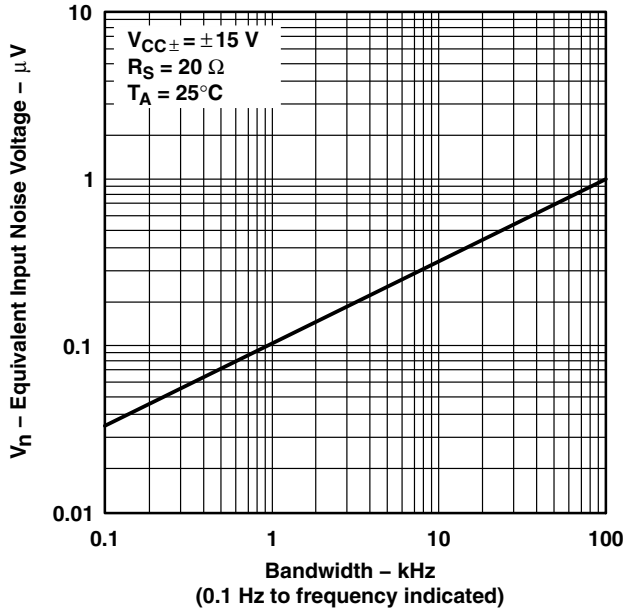

Figure 17

**OP27A
EQUIVALENT INPUT NOISE VOLTAGE
vs
TOTAL SUPPLY VOLTAGE**

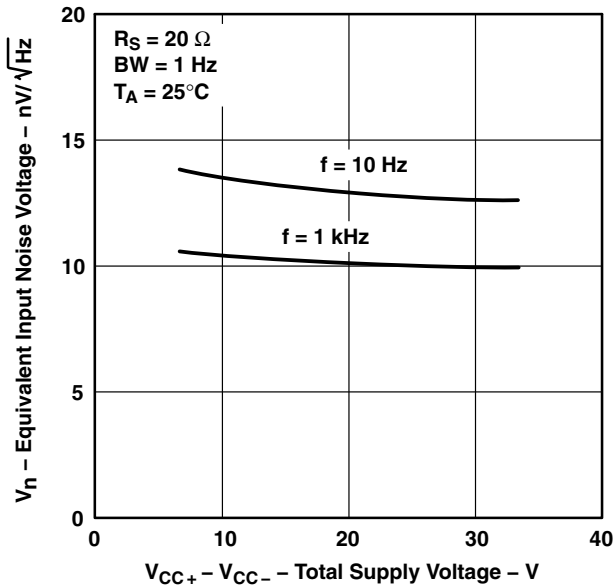

Figure 19

**TOTAL EQUIVALENT INPUT NOISE VOLTAGE
vs
SOURCE RESISTANCE**

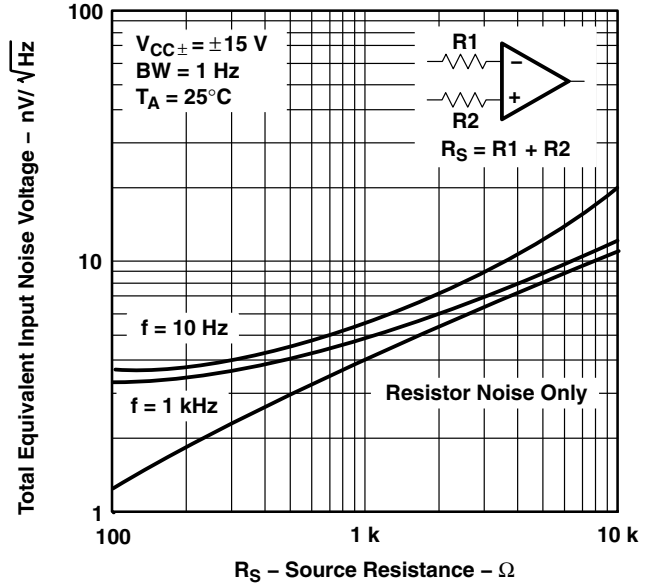

Figure 18

**OP27A
EQUIVALENT INPUT NOISE VOLTAGE
vs
FREE-AIR TEMPERATURE**

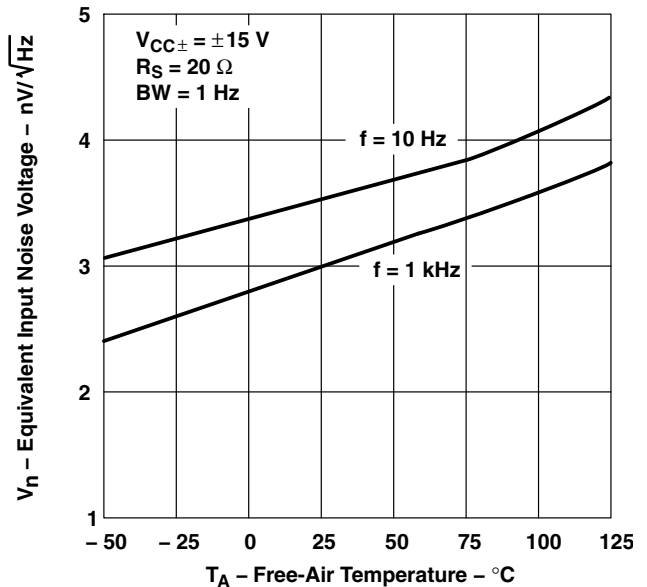
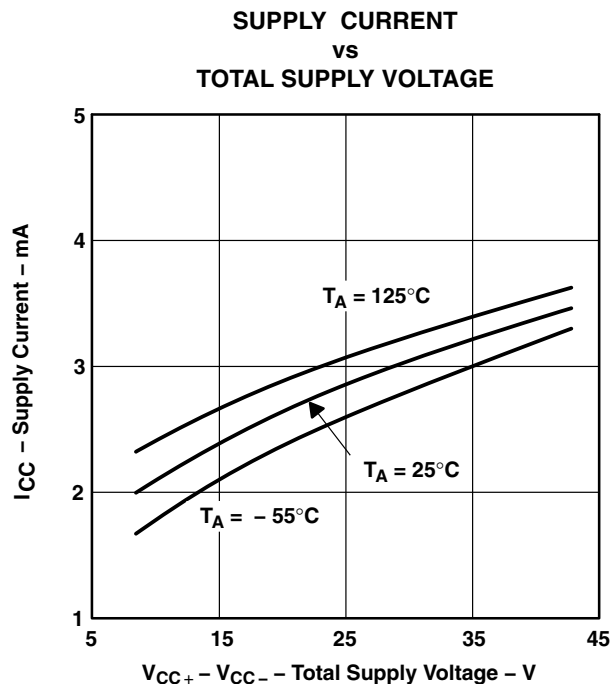
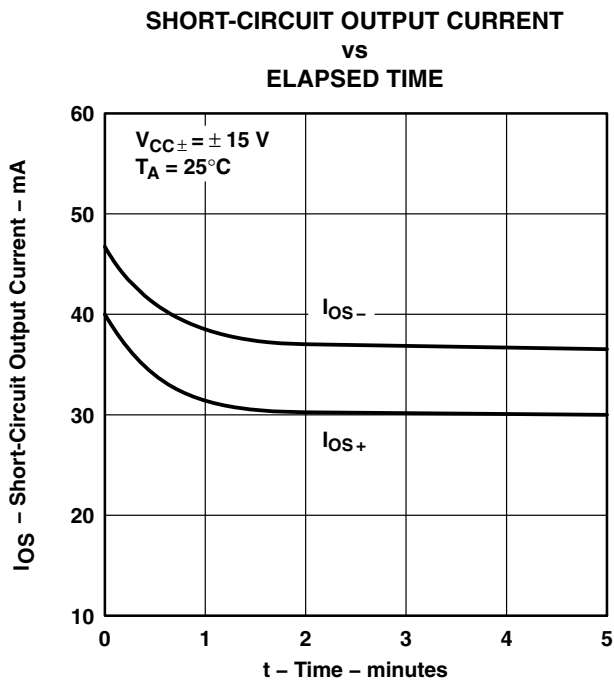
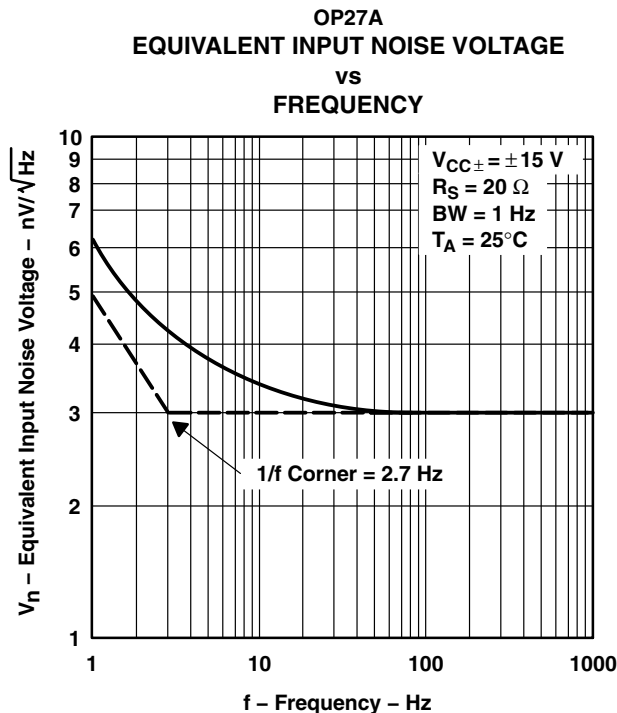

Figure 20



TYPICAL CHARACTERISTICS



OP27A, OP27C LOW-NOISE HIGH-SPEED PRECISION OPERATIONAL-AMPLIFIER

SLOS100E – FEBRUARY 1989 – REVISED FEBRUARY 2010

TYPICAL CHARACTERISTICS

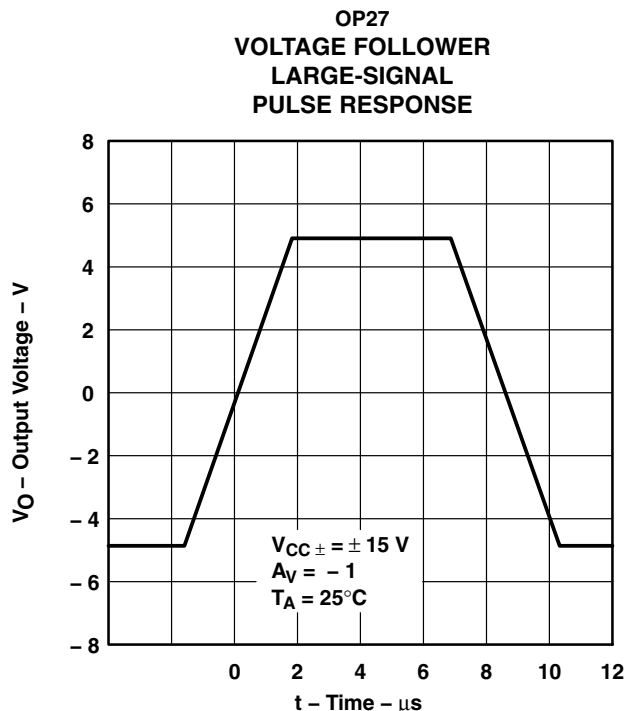
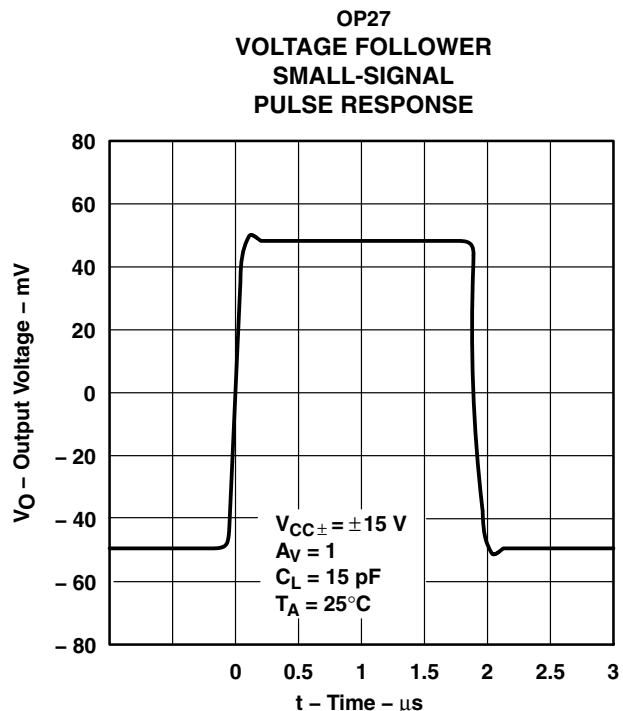

APPLICATION INFORMATION

general

The OP27 series devices can be inserted directly onto OP07, OP05, μ A725, and SE5534 sockets with or without removing external compensation or nulling components. In addition, the OP27 can be fitted to μ A741 sockets by removing or modifying external nulling components.

noise testing

Figure 26 shows a test circuit for 0.1-Hz to 10-Hz peak-to-peak noise measurement of the OP27. The frequency response of this noise tester indicates that the 0.1-Hz corner is defined by only one zero. Because the time limit acts as an additional zero to eliminate noise contributions from the frequency band below 0.1 Hz, the test time to measure 0.1-Hz to 10-Hz noise should not exceed 10 seconds.

Measuring the typical 80-nV peak-to-peak noise performance of the OP27 requires the following special test precautions:



POST OFFICE BOX 655303 • DALLAS, TEXAS 75265

APPLICATION INFORMATION

noise testing (continued)

1. The device should be warmed up for at least five minutes. As the operational amplifier warms up, the offset voltage typically changes $4\ \mu\text{V}$ due to the chip temperature increasing from 10°C to 20°C starting from the moment the power supplies are turned on. In the 10-s measurement interval, these temperature-induced effects can easily exceed tens of nanovolts.
2. For similar reasons, the device should be well shielded from air currents to eliminate the possibility of thermoelectric effects in excess of a few nanovolts, which would invalidate the measurements.
3. Sudden motion in the vicinity of the device should be avoided, as it produces a feedthrough effect that increases observed noise.

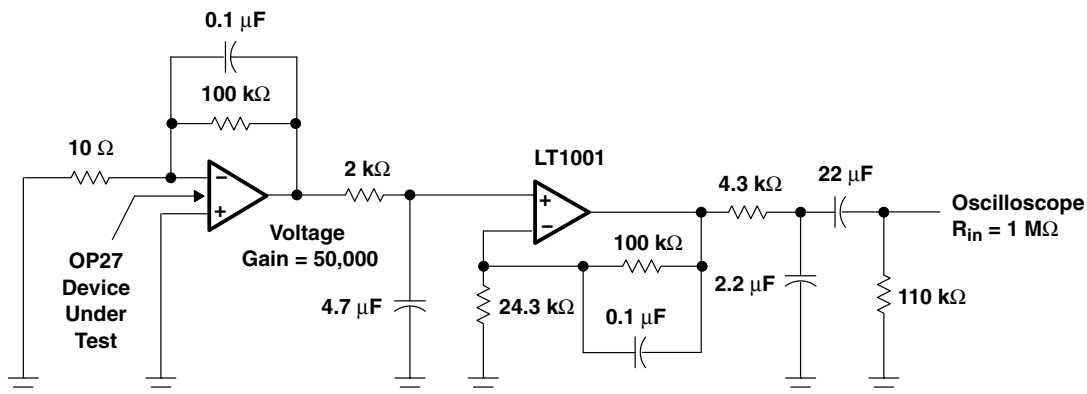
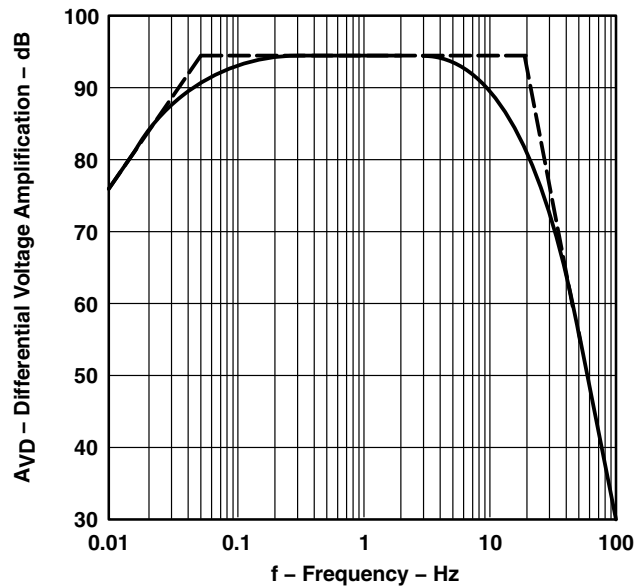

NOTE: All capacitor values are for nonpolarized capacitors only.

Figure 26. 0.1-Hz to 10-Hz Peak-to-Peak Noise Test Circuit and Frequency Response

OP27A, OP27C LOW-NOISE HIGH-SPEED PRECISION OPERATIONAL-AMPLIFIER

SLOS100E – FEBRUARY 1989 – REVISED FEBRUARY 2010

APPLICATION INFORMATION

noise testing (continued)

When measuring noise on a large number of units, a noise-voltage density test is recommended. A 10-Hz noise-voltage density measurement correlates well with a 0.1-Hz to 10-Hz peak-to-peak noise reading since both results are determined by the white noise and the location of the 1/f corner frequency.

Figure 27 shows a circuit measuring current noise and the formula for calculating current noise.

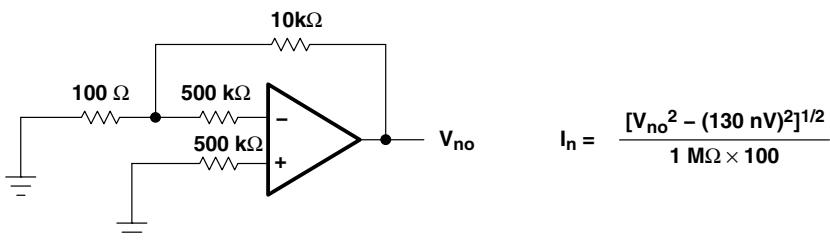

Figure 27. Current Noise Test Circuit and Formula

offset voltage adjustment

The input offset voltage and temperature coefficient of the OP27 are permanently trimmed to a low level at wafer testing. However, if further adjustment of V_{IO} is necessary, using a 10-kΩ nulling potentiometer as shown in Figure 28 does not degrade the temperature coefficient $\alpha_{V_{IO}}$. Trimming to a value other than zero creates an $\alpha_{V_{IO}}$ of $V_{IO}/300 \mu\text{V}/^\circ\text{C}$. For example, if V_{IO} is adjusted to 300 μV , the change in $\alpha_{V_{IO}}$ is 1 $\mu\text{V}/^\circ\text{C}$.

The adjustment range with a 10-kΩ potentiometer is approximately $\pm 2.5 \text{ mV}$. If a smaller adjustment range is needed, the sensitivity and resolution of the nulling can be improved by using a smaller potentiometer in conjunction with fixed resistors. The example in Figure 29 has an approximate null range of $\pm 200 \mu\text{V}$.

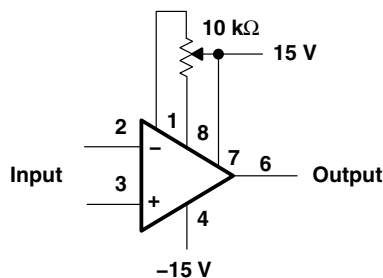

Figure 28. Standard Input Offset Voltage Adjustment

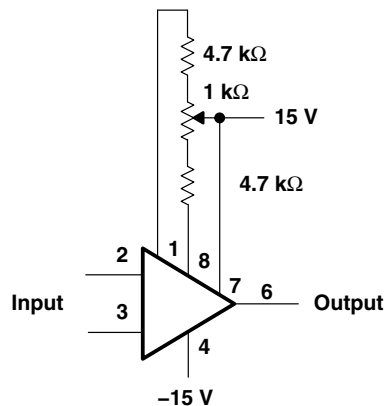

Figure 29. Input Offset Voltage Adjustment With Improved Sensitivity

offset voltage and drift

Unless proper care is exercised, thermoelectric effects caused by temperature gradients across dissimilar metals at the contacts to the input terminals can exceed the inherent temperature coefficient $\alpha_{V_{IO}}$ of the amplifier. Air currents should be minimized, package leads should be short, and the two input leads should be close together and at the same temperature.

APPLICATION INFORMATION

offset voltage and drift (continued)

The circuit shown in Figure 30 measures offset voltage. This circuit can also be used as the burn-in configuration for the OP27 with the supply voltage increased to 20 V, $R_1 = R_3 = 10\text{ k}\Omega$, $R_2 = 200\ \Omega$, and $A_{VD} = 100$.

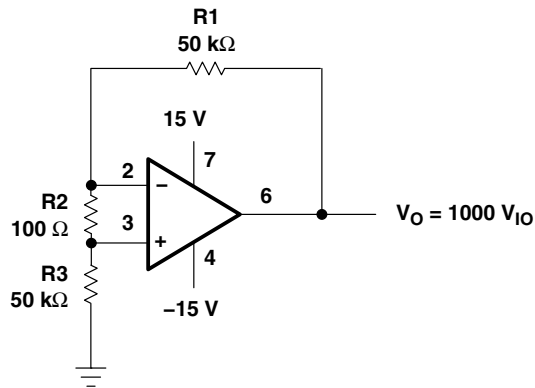

NOTE A: Resistors must have low thermoelectric potential.

Figure 30. Test Circuit for Offset Voltage and Offset Voltage Temperature Coefficient

unity gain buffer applications

The resulting output waveform, when $R_f \leq 100\ \Omega$ and the input is driven with a fast large-signal pulse ($>1\text{ V}$), is shown in the pulsed-operation diagram in Figure 31.

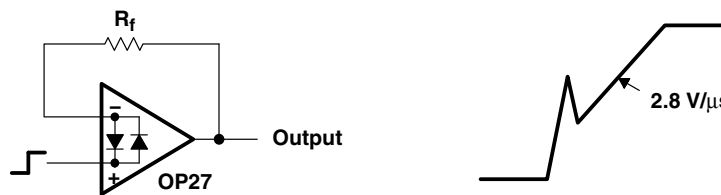

Figure 31. Pulsed Operation

During the initial (fast-feedthrough-like) portion of the output waveform, the input protection diodes effectively short the output to the input, and a current, limited only by the output short-circuit protection, is drawn by the signal generator. When $R_f \geq 500\ \Omega$, the output is capable of handling the current requirements (load current $\leq 20\text{ mA}$ at 10 V), the amplifier stays in its active mode, and a smooth transition occurs. When $R_f > 2\text{ k}\Omega$, a pole is created with R_f and the amplifier's input capacitance, creating additional phase shift and reducing the phase margin. A small capacitor (20 pF to 50 pF) in parallel with R_f eliminates this problem.

OP27A, OP27C LOW-NOISE HIGH-SPEED PRECISION OPERATIONAL-AMPLIFIER

SLOS100E – FEBRUARY 1989 – REVISED FEBRUARY 2010

APPLICATION INFORMATION

unity gain buffer applications (continued)

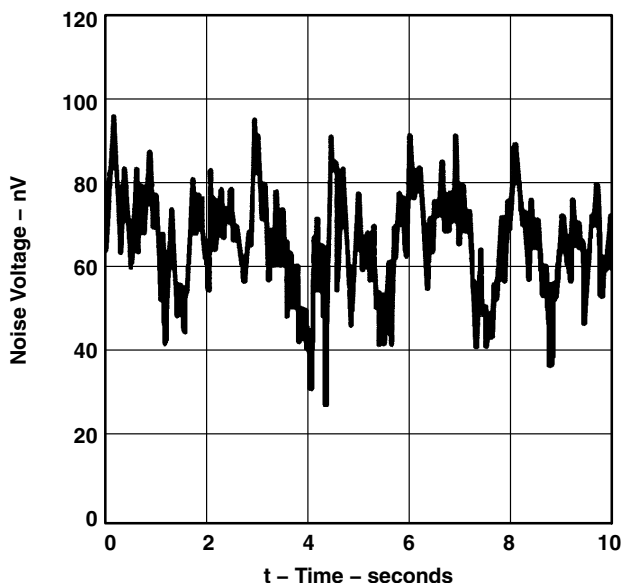

Type S Thermocouples
5.4 $\mu\text{V}/^\circ\text{C}$ at 0°C

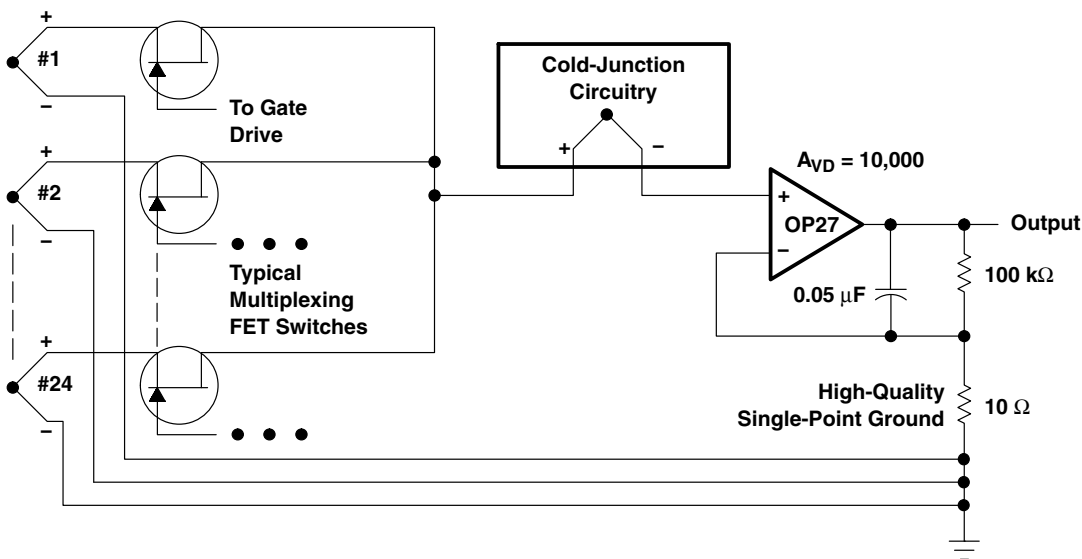

NOTE A: If 24 channels are multiplexed per second and the output is required to settle to 0.1 % accuracy, the amplifier's bandwidth cannot be limited to less than 30 Hz. The peak-to-peak noise contribution of the OP27 will still be only 0.11 μV , which is equivalent to an error of only 0.02°C .

Figure 32. Low-Noise, Multiplexed Thermocouple Amplifier and 0.1-Hz to 10-Hz Peak-to-Peak Noise Voltage

PACKAGING INFORMATION

Orderable Device	Status ⁽¹⁾	Package Type	Package Drawing	Pins	Package Qty	Eco Plan ⁽²⁾	Lead/ Ball Finish	MSL Peak Temp ⁽³⁾	Samples (Requires Login)
JM38510/13506BPA	ACTIVE	CDIP	JG	8	1	TBD	A42	N / A for Pkg Type	
M38510/13506BPA	ACTIVE	CDIP	JG	8	1	TBD	A42	N / A for Pkg Type	
OP27AFKB	ACTIVE	LCCC	FK	20	1	TBD	POST-PLATE	N / A for Pkg Type	
OP27AJGB	ACTIVE	CDIP	JG	8	1	TBD	A42	N / A for Pkg Type	
OP27CJGB	ACTIVE	CDIP	JG	8	1	TBD	A42	N / A for Pkg Type	

⁽¹⁾ The marketing status values are defined as follows:

ACTIVE: Product device recommended for new designs.

LIFEBUY: TI has announced that the device will be discontinued, and a lifetime-buy period is in effect.

NRND: Not recommended for new designs. Device is in production to support existing customers, but TI does not recommend using this part in a new design.

PREVIEW: Device has been announced but is not in production. Samples may or may not be available.

OBSELETE: TI has discontinued the production of the device.

⁽²⁾ Eco Plan - The planned eco-friendly classification: Pb-Free (RoHS), Pb-Free (RoHS Exempt), or Green (RoHS & no Sb/Br) - please check <http://www.ti.com/productcontent> for the latest availability information and additional product content details.

TBD: The Pb-Free/Green conversion plan has not been defined.

Pb-Free (RoHS): TI's terms "Lead-Free" or "Pb-Free" mean semiconductor products that are compatible with the current RoHS requirements for all 6 substances, including the requirement that lead not exceed 0.1% by weight in homogeneous materials. Where designed to be soldered at high temperatures, TI Pb-Free products are suitable for use in specified lead-free processes.

Pb-Free (RoHS Exempt): This component has a RoHS exemption for either 1) lead-based flip-chip solder bumps used between the die and package, or 2) lead-based die adhesive used between the die and leadframe. The component is otherwise considered Pb-Free (RoHS compatible) as defined above.

Green (RoHS & no Sb/Br): TI defines "Green" to mean Pb-Free (RoHS compatible), and free of Bromine (Br) and Antimony (Sb) based flame retardants (Br or Sb do not exceed 0.1% by weight in homogeneous material)

⁽³⁾ MSL, Peak Temp. -- The Moisture Sensitivity Level rating according to the JEDEC industry standard classifications, and peak solder temperature.

Important Information and Disclaimer: The information provided on this page represents TI's knowledge and belief as of the date that it is provided. TI bases its knowledge and belief on information provided by third parties, and makes no representation or warranty as to the accuracy of such information. Efforts are underway to better integrate information from third parties. TI has taken and continues to take reasonable steps to provide representative and accurate information but may not have conducted destructive testing or chemical analysis on incoming materials and chemicals. TI and TI suppliers consider certain information to be proprietary, and thus CAS numbers and other limited information may not be available for release.

In no event shall TI's liability arising out of such information exceed the total purchase price of the TI part(s) at issue in this document sold by TI to Customer on an annual basis.

JG (R-GDIP-T8)

CERAMIC DUAL-IN-LINE

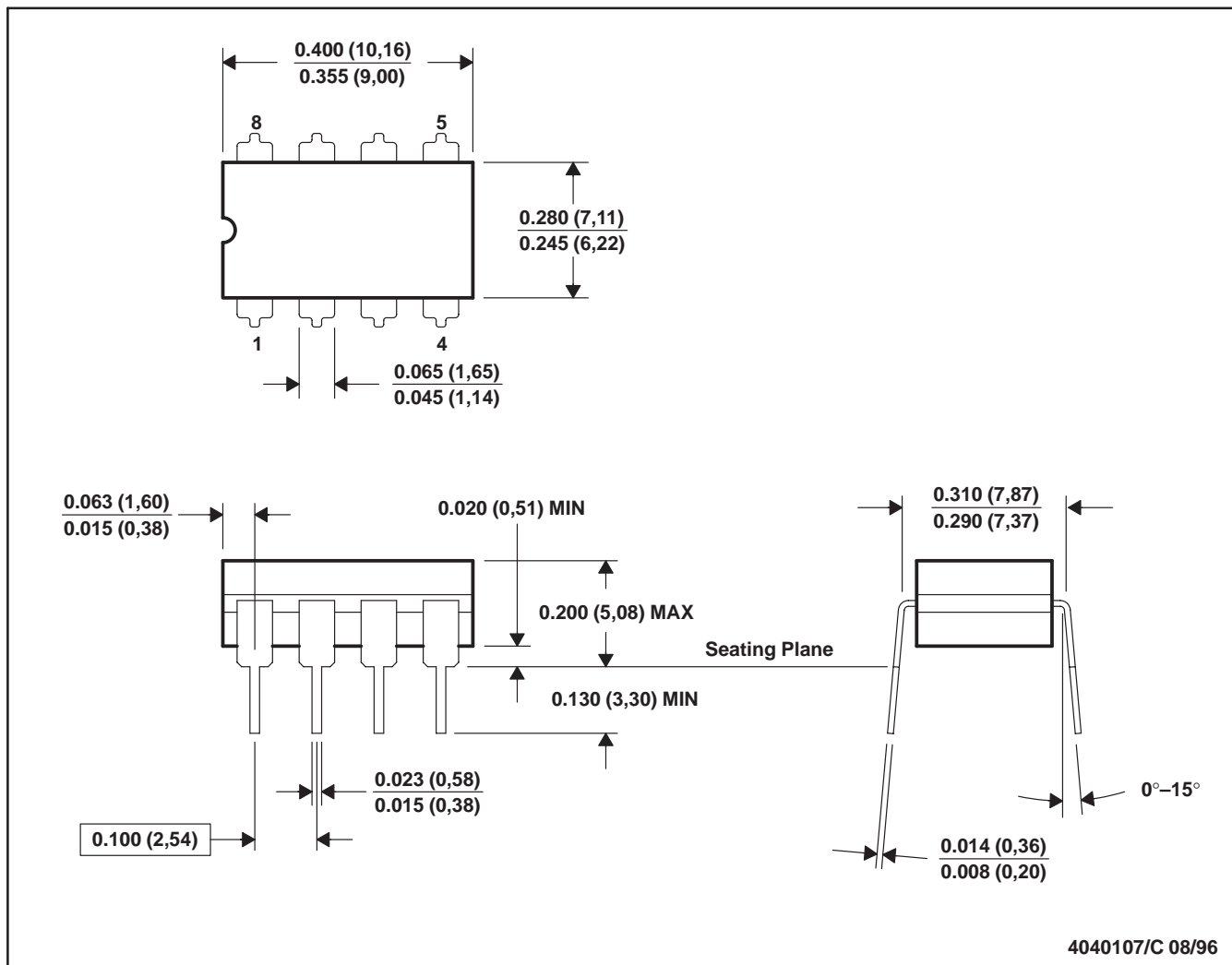

- NOTES: A. All linear dimensions are in inches (millimeters).
 B. This drawing is subject to change without notice.
 C. This package can be hermetically sealed with a ceramic lid using glass frit.
 D. Index point is provided on cap for terminal identification.
 E. Falls within MIL STD 1835 GDIP1-T8

FK (S-CQCC-N**)

LEADLESS CERAMIC CHIP CARRIER

28 TERMINAL SHOWN



NO. OF TERMINALS **	A		B	
	MIN	MAX	MIN	MAX
20	0.342 (8,69)	0.358 (9,09)	0.307 (7,80)	0.358 (9,09)
28	0.442 (11,23)	0.458 (11,63)	0.406 (10,31)	0.458 (11,63)
44	0.640 (16,26)	0.660 (16,76)	0.495 (12,58)	0.560 (14,22)
52	0.740 (18,78)	0.761 (19,32)	0.495 (12,58)	0.560 (14,22)
68	0.938 (23,83)	0.962 (24,43)	0.850 (21,6)	0.858 (21,8)
84	1.141 (28,99)	1.165 (29,59)	1.047 (26,6)	1.063 (27,0)



4040140/D 01/11

- NOTES:
- All linear dimensions are in inches (millimeters).
 - This drawing is subject to change without notice.
 - This package can be hermetically sealed with a metal lid.
 - Falls within JEDEC MS-004

IMPORTANT NOTICE

Texas Instruments Incorporated and its subsidiaries (TI) reserve the right to make corrections, modifications, enhancements, improvements, and other changes to its products and services at any time and to discontinue any product or service without notice. Customers should obtain the latest relevant information before placing orders and should verify that such information is current and complete. All products are sold subject to TI's terms and conditions of sale supplied at the time of order acknowledgment.

TI warrants performance of its hardware products to the specifications applicable at the time of sale in accordance with TI's standard warranty. Testing and other quality control techniques are used to the extent TI deems necessary to support this warranty. Except where mandated by government requirements, testing of all parameters of each product is not necessarily performed.

TI assumes no liability for applications assistance or customer product design. Customers are responsible for their products and applications using TI components. To minimize the risks associated with customer products and applications, customers should provide adequate design and operating safeguards.

TI does not warrant or represent that any license, either express or implied, is granted under any TI patent right, copyright, mask work right, or other TI intellectual property right relating to any combination, machine, or process in which TI products or services are used. Information published by TI regarding third-party products or services does not constitute a license from TI to use such products or services or a warranty or endorsement thereof. Use of such information may require a license from a third party under the patents or other intellectual property of the third party, or a license from TI under the patents or other intellectual property of TI.

Reproduction of TI information in TI data books or data sheets is permissible only if reproduction is without alteration and is accompanied by all associated warranties, conditions, limitations, and notices. Reproduction of this information with alteration is an unfair and deceptive business practice. TI is not responsible or liable for such altered documentation. Information of third parties may be subject to additional restrictions.

Resale of TI products or services with statements different from or beyond the parameters stated by TI for that product or service voids all express and any implied warranties for the associated TI product or service and is an unfair and deceptive business practice. TI is not responsible or liable for any such statements.

TI products are not authorized for use in safety-critical applications (such as life support) where a failure of the TI product would reasonably be expected to cause severe personal injury or death, unless officers of the parties have executed an agreement specifically governing such use. Buyers represent that they have all necessary expertise in the safety and regulatory ramifications of their applications, and acknowledge and agree that they are solely responsible for all legal, regulatory and safety-related requirements concerning their products and any use of TI products in such safety-critical applications, notwithstanding any applications-related information or support that may be provided by TI. Further, Buyers must fully indemnify TI and its representatives against any damages arising out of the use of TI products in such safety-critical applications.

TI products are neither designed nor intended for use in military/aerospace applications or environments unless the TI products are specifically designated by TI as military-grade or "enhanced plastic." Only products designated by TI as military-grade meet military specifications. Buyers acknowledge and agree that any such use of TI products which TI has not designated as military-grade is solely at the Buyer's risk, and that they are solely responsible for compliance with all legal and regulatory requirements in connection with such use.

TI products are neither designed nor intended for use in automotive applications or environments unless the specific TI products are designated by TI as compliant with ISO/TS 16949 requirements. Buyers acknowledge and agree that, if they use any non-designated products in automotive applications, TI will not be responsible for any failure to meet such requirements.

Following are URLs where you can obtain information on other Texas Instruments products and application solutions:

Products

Audio	www.ti.com/audio
Amplifiers	amplifier.ti.com
Data Converters	dataconverter.ti.com
DLP® Products	www.dlp.com
DSP	dsp.ti.com
Clocks and Timers	www.ti.com/clocks
Interface	interface.ti.com
Logic	logic.ti.com
Power Mgmt	power.ti.com
Microcontrollers	microcontroller.ti.com
RFID	www.ti-rfid.com
OMAP Mobile Processors	www.ti.com/omap
Wireless Connectivity	www.ti.com/wirelessconnectivity

Applications

Automotive and Transportation	www.ti.com/automotive
Communications and Telecom	www.ti.com/communications
Computers and Peripherals	www.ti.com/computers
Consumer Electronics	www.ti.com/consumer-apps
Energy and Lighting	www.ti.com/energy
Industrial	www.ti.com/industrial
Medical	www.ti.com/medical
Security	www.ti.com/security
Space, Avionics and Defense	www.ti.com/space-avionics-defense
Video and Imaging	www.ti.com/video

TI E2E Community Home Page

e2e.ti.com

Mailing Address: Texas Instruments, Post Office Box 655303, Dallas, Texas 75265
Copyright © 2012, Texas Instruments Incorporated